

Multiobjective Output-Feedback Control via LMI Optimization

Carsten Scherer, *Member, IEEE*, Pascal Gahinet, *Member, IEEE*, and Mahmoud Chilali

Abstract—This paper presents an overview of a linear matrix inequality (LMI) approach to the multiobjective synthesis of linear output-feedback controllers. The design objectives can be a mix of H_∞ performance, H_2 performance, passivity, asymptotic disturbance rejection, time-domain constraints, and constraints on the closed-loop pole location. In addition, these objectives can be specified on different channels of the closed-loop system. When all objectives are formulated in terms of a common Lyapunov function, controller design amounts to solving a system of linear matrix inequalities. The validity of this approach is illustrated by a realistic design example.

Index Terms—Controller parameter change, linear matrix inequalities, Lyapunov shaping paradigm, multichannel multiobjective control.

I. INTRODUCTION

LINEAR matrix inequalities (LMI's) have emerged as a powerful formulation and design technique for a variety of linear control problems [9]. Since solving LMI's is a convex optimization problem, such formulations offer a numerically tractable means of attacking problems that lack an analytical solution. In addition, efficient interior-point algorithms are now available to solve the generic LMI problems with a polynomial-time worst-case complexity [8], [18], [25], [26], [32]. Consequently, reducing a control design problem to an LMI can be considered as a practical solution to this problem [9].

General multiobjective control problems are difficult and remain mostly open to this date. By multiobjective control, we refer to synthesis problems with a mix of time- and frequency-domain specifications ranging from H_2 and H_∞ performance to regional pole placement, asymptotic tracking or regulation, and settling time or saturation constraints.

For the multiobjective H_2/H_∞ problem, it has been proposed to specify the closed-loop objectives in terms of a common Lyapunov function [7], [22]. This still guarantees the desired specifications at the expense of conservatism. As a benefit, controller design can be reduced to a convex optimization problem [22]. The same technique has proved valuable in arriving at design procedures for various state-feedback

control problems [5], [9], [11], [22]. In [29], a complete LMI treatment of the general mixed H_2/H_∞ output-feedback synthesis problem was presented. This work eventually led to realizing that output-feedback problems could be "linearized" by a mere change of controller variables, much like in the state-feedback case [11], [30]. While this change of variable is more sophisticated than its state-feedback counterpart, it offers an equally systematic means of turning output-feedback specifications into LMI's. We would like to stress that similar ideas emerged in the other independent works [23], [24].

The main purpose of this paper is to give a fairly complete overview of the design technique that guarantees the desired closed-loop specification in terms of a *single* Lyapunov function. The objectives addressed here include H_2 and H_∞ performance, passivity, peak output amplitude, peak-to-peak gain, nominal and robust regulation, and regional pole placement. While most of these results are easily obtained by applying the controller parameter transformation proposed in [11], [23], and [30], the extension to nominal regulation requires a modification that is new and reveals the potential to address an even larger class of problems.

The paper is organized as follows. Section II gives the problem statement and motivations. Section III reviews the various specifications and objectives that can be formulated in terms of LMI's. Section IV discusses the design methodology and its interpretation as a "Lyapunov shaping" paradigm. It also defines the critical change of controller variables that allows us to linearize the problem and turns it into a set of LMI's. Section V lists the resulting LMI constraints for each individual specification and discusses how they can be combined to solve various multiobjective problems. Section VI comments on reduced-order controller design, and Section VII illustrates this approach on a realistic design example.

The notation is fairly standard. The compact notation

$$\left[\begin{array}{c|c} A & B \\ \hline C & D \end{array} \right]$$

is used to denote the transfer function $G(s) = D + C(sI - A)^{-1}B$.

II. PROBLEM STATEMENT AND MOTIVATIONS

This paper deals with multiobjective output-feedback synthesis for multi-input/multi-output (MIMO) linear time-invariant (LTI) systems. This section gives a formal statement of the problem and defines the relevant notation. The LTI

Manuscript received December 8, 1995; revised January 20, 1997. Recommended by Associate Editor, A. Vicino.

C. Scherer is with the Mechanical Engineering Systems and Control Group, Delft University of Technology, 2628 CD Delft, The Netherlands (e-mail: c.scherer@wbmt.tudelft.nl).

P. Gahinet is with The MathWorks Inc., Natick, MA 01760-1500 USA.

M. Chilali is with INRIA Rocquencourt, Domaine de Voluceau, BP 105, 78153 Le Chesnay Cedex, France.

Publisher Item Identifier S 0018-9286(97)05069-1.

plant is given by the state-space equations

$$P \begin{cases} \dot{x} = Ax + B_w w + Bu \\ z = C_z x + D_{zw} w + D_z u \\ y = Cx + D_w w \end{cases} \quad (1)$$

where $u \in \mathbf{R}^{n_u}$ is the control input, w is a vector of exogenous inputs (such as reference signals, disturbance signals, sensor noise), $y \in \mathbf{R}^{n_y}$ is the measured output, and z is a vector of output signals related to the performance of the control system.

Let T denote the closed-loop transfer functions from w to z for some dynamical output-feedback control law $u = Ky$. Our goal is to compute a dynamical output-feedback controller

$$K \begin{cases} \dot{\zeta} = A_K \zeta + B_K y \\ u = C_K \zeta + D_K y \end{cases} \quad (2)$$

that meets various specifications on the closed-loop behavior. Typically, these specifications are defined for particular channels or combinations of channels. More precisely, each specification or objective is formulated relative to some closed-loop transfer function of the form

$$T_j = L_j T R_j \quad (3)$$

where the matrices L_j, R_j select the appropriate input/output (I/O) channels or channel combinations. Unlike previous work [13], [22], our approach does not require that the selected input or output channels are the same for all objectives. Rather, the multiobjective problem considered here is intrinsically *multichannel*.

The specifications and objectives under consideration include H_∞ performance, H_2 performance, dissipativeness, time-domain constraints (peak amplitude, overshoot, settling time), and regulation. Additional regional constraints on the closed-loop poles can also be imposed. The motivations for using such a mix of performance measures are as follows.

- The H_∞ performance is convenient to enforce robustness to model uncertainty and to express frequency-domain specifications such as bandwidth, low-frequency gain, and roll-off.
- The H_2 performance is useful to handle stochastic aspects such as measurement noise and random disturbance.
- Passivity requirements appear in specific control systems such as flexible structures and circuits.
- Time-domain constraints are useful to tune the transient response and peak amplitudes such as the peak of the impulse response, the overshoot of the step response, or the peak control input.
- It is often desirable to enforce some minimum decay rate or closed-loop damping via regional pole assignment [11]. In addition, pole constraints are useful to avoid fast dynamics and high-frequency gain in the controller, which in turn facilitate its digital implementation.
- A general goal is the asymptotic rejection of disturbance or tracking of reference signals that are generated by a known model (integral control).

In summation, multiobjective design allows for more flexible and accurate specification of the desirable closed-loop behavior.

Henceforth, all specifications and objectives are expressed in terms of the transfer function T_j , keeping in mind that T_j refers to any particular I/O channel in the closed-loop mapping. Since our approach is state-space based, we first provide a state-space realization for T_j and introduce some useful shorthand notation. With the plant P and controller K defined as above, the closed-loop system admits the realization

$$T \begin{cases} \dot{x}_{cl} = Ax_{cl} + Bw \\ z = Cx_{cl} + Dw \end{cases} \quad (4)$$

where

$$\begin{pmatrix} A & B \\ C & D \end{pmatrix} = \left(\begin{array}{cc|c} A + BD_K C & BC_K & B_w + BD_K D_w \\ B_K C & A_K & B_K D_w \\ \hline C_z + D_z D_K C & D_z C_K & D_{zw} + D_z D_K D_w \end{array} \right).$$

With

$$\begin{aligned} B_j &:= B_w R_j, & C_j &:= L_j C_z, & D_j &:= L_j D_{zw} R_j \\ E_j &:= L_j D_z, & F_j &:= D_w R_j \end{aligned}$$

it is readily verified that a realization of $T_j(s) = L_j T(s) R_j$ is given by

$$\begin{aligned} &\begin{pmatrix} A & B_j \\ C_j & D_j \end{pmatrix} \\ &:= \begin{pmatrix} A & B R_j \\ L_j C & L_j D R_j \end{pmatrix} \\ &= \left(\begin{array}{cc|c} A + BD_K C & BC_K & B_j + BD_K F_j \\ B_K C & A_K & B_K F_j \\ \hline C_j + E_j D_K C & E_j C_K & D_j + E_j D_K F_j \end{array} \right). \quad (5) \end{aligned}$$

Note that $T_j(s)$ is nothing but the transfer function from w_j to z_j if specifying the input and output signals in (4) as $w = R_j w_j$ and $z_j = L_j z$.

III. LMI FORMULATION OF THE DESIGN SPECIFICATIONS

This section gives an overview of the various closed-loop specifications and objectives that can be captured in the LMI framework. All LMI characterizations listed below have the following common origin: let \mathcal{A} and x_{cl} denote the closed-loop state matrix and state vector, respectively. Since the controller has to be internally stabilizing, the closed-loop system must admit a quadratic Lyapunov function

$$V(x_{cl}) = x_{cl}^T \mathcal{P} x_{cl}, \quad \mathcal{P} > 0 \quad (6)$$

such that

$$\mathcal{A}^T \mathcal{P} + \mathcal{P} \mathcal{A} < 0. \quad (7)$$

The LMI approach consists of expressing each control specification or objective as an additional constraint on admissible

closed-loop Lyapunov functions satisfying (6) and (7). In the multichannel spirit, we consider specifications on a generic closed-loop transfer function $T_j(s) = L_j T(s) R_j$, whose realization is given in (5). The corresponding LMI constraints are therefore formulated in terms of the state-space matrices A, B_j, C_j, D_j .

Remark 1: Given a quadratic function $Q(w_j, z_j)$, we use the shorthand notation $Q(w_j, z_j) \ll 0$ to denote the existence of $\epsilon > 0$ such that $Q(w_j, z_j) \leq -\epsilon w_j^T w_j$ for all w_j . Similarly

$$\int_0^T Q(w_j(t), z_j(t)) dt \ll 0$$

means that

$$\int_0^T Q(w_j(t), z_j(t)) dt \leq -\epsilon \int_0^T w_j(t)^T w_j(t) dt$$

holds for all square-integrable inputs $w_j(\cdot)$ and some fixed $\epsilon > 0$.

A. H_∞ Performance

Let $\|T_j\|_\infty$ denote the H_∞ norm of T_j , that is, its largest gain across frequency in the singular value norm [15]. The H_∞ norm measures the system input-output gain for finite energy or finite rms input signals. The constraint $\|T_j\|_\infty < \gamma$ can be interpreted as a disturbance rejection performance. This constraint is also useful to enforce robust stability. Specifically, it guarantees that the closed-loop system remains stable for all perturbations $w = R_j \Delta L_j z$, with Δ having incremental gain not larger than $1/\gamma$.

By virtue of the Bounded Real Lemma [4], [28], \mathcal{A} is stable and the H_∞ norm of T_j is smaller than γ if and only if there exists a symmetric \mathcal{P} with

$$\begin{pmatrix} A^T \mathcal{P} + \mathcal{P} A & \mathcal{P} B_j & C_j^T \\ B_j^T \mathcal{P} & -\gamma I & D_j^T \\ C_j & D_j & -\gamma I \end{pmatrix} < 0, \quad \mathcal{P} > 0. \quad (8)$$

B. General Quadratic Constraints

Given fixed matrices $U_j \geq 0$, $V_j = V_j^T$, and W_j , the previous characterization extends to more general quadratic constraints on $w_j(\cdot)$, $z_j(\cdot)$ of the form

$$\int_0^T \begin{pmatrix} z_j(t) \\ w_j(t) \end{pmatrix}^T \begin{pmatrix} U_j & W_j \\ W_j^T & V_j \end{pmatrix} \begin{pmatrix} z_j(t) \\ w_j(t) \end{pmatrix} dt \ll 0 \quad (9)$$

for $x_{cl}(0) = 0$ and all $T \geq 0$, $w_j \in L_2$ (with \ll defined in Remark 1).

Important special cases include:

- the H_∞ constraint $\|T_j\|_\infty < \gamma$ which corresponds to $U_j = (1/\gamma)I$, $V_j = -\gamma I$, $W_j = 0$;
- the strict passivity constraint $T_j(i\omega) + T_j(i\omega)^* > 0$ for all $\omega \in \mathbf{R} \cup \{\infty\}$ which corresponds to $U_j = 0$, $V_j = 0$, $W_j = -I$;
- sector constraints: with $U_j = I$, $V_j = -\alpha\beta I$, $W_j = -\frac{1}{2}(\alpha + \beta)I$, (9) reads

$$\int_0^T (z_j(t) - \alpha w_j(t))^T (z_j(t) - \beta w_j(t)) dt \ll 0$$

which is to say that the mapping $T_j = L_j T R_j$ lies in the sector $\{\alpha, \beta\}$.

Suppose that $\mathcal{P} > 0$ and

$$\begin{pmatrix} A^T \mathcal{P} + \mathcal{P} A & \mathcal{P} B_j \\ B_j^T \mathcal{P} & 0 \end{pmatrix} + \begin{pmatrix} C_j & D_j \\ 0 & I \end{pmatrix}^T \cdot \begin{pmatrix} U_j & W_j \\ W_j^T & V_j \end{pmatrix} \begin{pmatrix} C_j & D_j \\ 0 & I \end{pmatrix} < 0. \quad (10)$$

Recalling that $z_j = C_j x_{cl} + D_j w_j$ and that

$$\frac{d}{dt} V(x_{cl}(t)) = \begin{pmatrix} x_{cl}(t) \\ w_j(t) \end{pmatrix}^T \begin{pmatrix} A^T \mathcal{P} + \mathcal{P} A & \mathcal{P} B_j \\ B_j^T \mathcal{P} & 0 \end{pmatrix} \begin{pmatrix} x_{cl}(t) \\ w_j(t) \end{pmatrix}$$

for V defined in (6), we infer from (10) that

$$\frac{d}{dt} V(x_{cl}(t)) + \begin{pmatrix} z_j(t) \\ w_j(t) \end{pmatrix}^T \begin{pmatrix} U_j & W_j \\ W_j^T & V_j \end{pmatrix} \begin{pmatrix} z_j(t) \\ w_j(t) \end{pmatrix} \ll 0. \quad (11)$$

Integration from $t = 0$ to $t = T$ then yields

$$x_{cl}^T(T) \mathcal{P} x_{cl}(T) + \int_0^T \begin{pmatrix} z_j(t) \\ w_j(t) \end{pmatrix}^T \cdot \begin{pmatrix} U_j & W_j \\ W_j^T & V_j \end{pmatrix} \begin{pmatrix} z_j(t) \\ w_j(t) \end{pmatrix} dt \ll 0$$

and (9) follows by observing that $x_{cl}^T(T) \mathcal{P} x_{cl}(T) \geq 0$.

Conversely, (9) implies that there exists an $\epsilon > 0$ with

$$\int_0^T \begin{pmatrix} z_j(t) \\ w_j(t) \end{pmatrix}^T \begin{pmatrix} U_j & W_j \\ W_j^T & V_j \end{pmatrix} \begin{pmatrix} z_j(t) \\ w_j(t) \end{pmatrix} + \begin{pmatrix} x_{cl}(t) \\ w_j(t) \end{pmatrix}^T \begin{pmatrix} \epsilon I & 0 \\ 0 & \epsilon I \end{pmatrix} \begin{pmatrix} x_{cl}(t) \\ w_j(t) \end{pmatrix} dt \leq 0.$$

By standard results from indefinite linear-quadratic (LQ) theory [33], we conclude that there exists a symmetric \mathcal{P} satisfying

$$\begin{pmatrix} A^T \mathcal{P} + \mathcal{P} A & \mathcal{P} B_j \\ B_j^T \mathcal{P} & 0 \end{pmatrix} + \begin{pmatrix} C_j & D_j \\ 0 & I \end{pmatrix}^T \cdot \begin{pmatrix} U_j & W_j \\ W_j^T & V_j \end{pmatrix} \begin{pmatrix} C_j & D_j \\ 0 & I \end{pmatrix} + \epsilon I \leq 0.$$

(The controllability hypothesis in [33] can be weakened to stabilizability by a perturbation argument.) This implies (10). In addition, the left-upper block of (10) reads $A^T \mathcal{P} + \mathcal{P} A + C_j^T U_j C_j < 0$, which implies $\mathcal{P} > 0$, since \mathcal{A} is stable and $U_j \geq 0$.

Hence, we have proved that the existence of a positive definite solution of (10) is necessary and sufficient for \mathcal{A} to be stable and (9) to hold.

For the purpose of synthesis we need to rewrite (10). We factorize $U_j \geq 0$ as

$$U_j = Q_j \Sigma_j^{-1} Q_j^T, \quad \Sigma_j > 0.$$

Then (10) is equivalent to

$$\begin{pmatrix} A^T \mathcal{P} + \mathcal{P} A & \mathcal{P} B_j + C_j^T W_j \\ B_j^T \mathcal{P} + W_j^T C_j & D_j^T W_j + W_j^T D_j + V_j \end{pmatrix} + \begin{pmatrix} C_j^T \\ D_j^T \end{pmatrix} Q_j \Sigma_j^{-1} Q_j^T \begin{pmatrix} C_j & D_j \end{pmatrix} < 0.$$

A Schur complement argument leads to the final analysis LMI's

$$\begin{pmatrix} A^T \mathcal{P} + \mathcal{P}A & \mathcal{P}B_j + C_j^T W_j & C_j^T Q_j \\ B_j^T \mathcal{P} + W_j^T C_j & W_j^T D_j + D_j^T W_j + V_j & D_j^T Q_j \\ Q_j^T C_j & Q_j^T D_j & -\Sigma_j \end{pmatrix} \begin{matrix} \mathcal{P} > 0 \\ < 0 \\ < 0 \end{matrix} \quad (12)$$

for general quadratic performance.

C. H_2 Performance

Assume \mathcal{A} is stable and $D_j = 0$. The H_2 norm of T_j is defined by

$$\|T_j\|_2^2 := \frac{1}{2\pi} \int_{-\infty}^{+\infty} \text{Tr}(T_j(i\omega)^H T_j(i\omega)) d\omega$$

and corresponds to the asymptotic variance of the output $z_j = L_j z$ when the system is driven by $w = R_j w_j$ with white noise w_j . It is well known that this norm can be computed as $\|T_j\|_2^2 = \text{Tr}(C_j S_0 C_j^T)$, where S_0 solves the Lyapunov equation

$$A S_0 + S_0 A^T + B_j B_j^T = 0.$$

Since $S_0 < S$ for any S satisfying

$$A S + S A^T + B_j B_j^T < 0 \quad (13)$$

it is readily verified that $\|T_j\|_2^2 < \nu$ if and only if there exists $S > 0$ satisfying (13) and $\text{Tr}(C_j S C_j^T) < \nu$. With an auxiliary parameter Q , we obtain the following analysis result: \mathcal{A} is stable and $\|T_j\|_2^2 < \nu$ iff there exist symmetric $\mathcal{P} := S^{-1}$ and Q such that

$$\begin{pmatrix} A^T \mathcal{P} + \mathcal{P}A & \mathcal{P}B_j \\ B_j^T \mathcal{P} & -I \end{pmatrix} < 0 \\ \begin{pmatrix} \mathcal{P} & C_j^T \\ C_j & Q \end{pmatrix} > 0 \\ \text{Tr}(Q) < \nu, \quad D_j = 0. \quad (14)$$

D. Generalized H_2 Performance

The H_∞ norm considered in Section III-A gives the system gain when both the input and the output are measured in the energy or L_2 norm. Rather than bounding the output energy, it may be desirable to keep the peak amplitude of the output z_j below a certain level, e.g., to avoid actuator saturations. If the input w_j is still quantified by its energy, this leads to considering the so-called generalized H_2 -norm defined by

$$\|T_j\|_g := \sup \left\{ \|z_j(T)\| : x_{cl}(0) = 0, \right. \\ \left. T \geq 0, \int_0^T \|w_j(t)\|^2 dt \leq 1 \right\}. \quad (15)$$

This measures the peak amplitude of the output signal $z_j(t)$ over all unit-energy inputs $w_j(t)$.

Suppose that there exists a symmetric matrix \mathcal{P} satisfying

$$\begin{pmatrix} A^T \mathcal{P} + \mathcal{P}A & \mathcal{P}B_j \\ B_j^T \mathcal{P} & -I \end{pmatrix} < 0 \\ \begin{pmatrix} \mathcal{P} & C_j^T \\ C_j & \alpha I \end{pmatrix} > 0, \quad D_j = 0. \quad (16)$$

The first inequality ensures that $(d/dt)V(x_{cl}(t)) - w_j(t)^T w_j(t) \ll 0$, which yields after integration

$$V(x_{cl}(T)) \ll \int_0^T w_j(t)^T w_j(t) dt.$$

Meanwhile, the second inequality implies that $(1/\alpha)C_j^T C_j < \mathcal{P}$, and thus $z_j(T)^T z_j(T) \leq \alpha V(x_{cl}(T))$. Combining these two inequalities leads to

$$z_j(T)^T z_j(T) \ll \alpha \int_0^T w_j(t)^T w_j(t) dt$$

for all $T \geq 0$, whence $\|T_j\|_g^2 < \alpha$. It is not difficult to show that the solvability of (16) is also necessary for this norm bound to hold [27].

E. Peak Impulse Response and Settling Time

Suppose that $D_j = 0$ and that $T_j(s)$ is single input. Then the impulse response $z_j(t)$ coincides with the output of the system

$$\begin{cases} \dot{x}_{cl} = A x_{cl}, & x_{cl}(0) = B_j \\ z_j = C_j x_{cl}. \end{cases}$$

Following [9], a sufficient condition to guarantee that $\|z_j(t)\| < \xi$ for all $t \geq 0$ is the existence of a symmetric \mathcal{P} such that

$$A^T \mathcal{P} + \mathcal{P}A < 0, \quad \begin{pmatrix} \mathcal{P} & \mathcal{P}B_j \\ B_j^T \mathcal{P} & \xi I \end{pmatrix} > 0 \\ \begin{pmatrix} \mathcal{P} & C_j^T \\ C_j & \xi I \end{pmatrix} > 0, \quad D_j = 0. \quad (17)$$

Indeed, the inequalities respectively ensure that, for all $t \geq 0$

$$x_{cl}^T(t) \mathcal{P} x_{cl}(t) \leq B_j^T \mathcal{P} B_j, \quad B_j^T \mathcal{P} B_j < \xi \\ z_j^T(t) z_j(t) \leq \xi x_{cl}^T(t) \mathcal{P} x_{cl}(t)$$

and the bound $\|z_j(t)\| < \xi$ readily follows. Note that unlike most LMI characterizations given in this section, the LMI conditions (17) are only sufficient and can prove fairly conservative in some cases.

If replacing the first inequality in (17) by $A^T \mathcal{P} + \mathcal{P}A + 2\alpha \mathcal{P} < 0$, the bound on $\|z_j(t)\|$ can be improved to $\|z_j(t)\| < \xi e^{-\alpha t}$. This can be used to impose an upper bound on the settling time through the appropriate choice of $\alpha > 0$ [9].

F. Bounds on the Peak-to-Peak Gain

The generalized H_2 norm measures the peak amplitude of the output over unit-energy inputs. Suppose, instead, that the input signal w_j is only bounded in amplitude. To bound the

peak amplitude of z_j , we then need to consider the so-called peak-to-peak gain of T_j defined by

$$\|T_j\|_{\text{peak}} := \sup \{ \|z_j(T)\| : x_{cl}(0) = 0, T \geq 0, \\ \|w(t)\| \leq 1 \text{ for } t \geq 0 \}.$$

This measures the peak norm of the output signal $z_j(t)$ for inputs $w_j(t)$ whose amplitude do not exceed one. Note that $\|T_j\|_{\infty} \leq \|T_j\|_{\text{peak}}$ as is easily seen by considering a sinusoidal input with frequency ω such that $\sigma_{\max}(T_j(j\omega)) = \|T_j\|_{\infty}$.

To date there is no exact characterization of the peak-to-peak norm in the LMI framework. However, it is possible to derive upper bounds for $\|T_j\|_{\text{peak}}$ along the lines of [3] and [9]. Suppose that \mathcal{P} , λ , μ , and ζ satisfy

$$\begin{pmatrix} \mathcal{A}^T \mathcal{P} + \mathcal{P} \mathcal{A} + \lambda \mathcal{P} & \mathcal{P} \mathcal{B}_j \\ \mathcal{B}_j^T \mathcal{P} & -\mu I \end{pmatrix} \begin{matrix} \lambda > 0 \\ < 0 \end{matrix} \\ \begin{pmatrix} \lambda \mathcal{P} & 0 & \mathcal{C}_j^T \\ 0 & (\zeta - \mu)I & \mathcal{D}_j^T \\ \mathcal{C}_j & \mathcal{D}_j & \zeta I \end{pmatrix} > 0. \quad (18)$$

Choose any $w_j(\cdot)$ with $w_j(t)^T w_j(t) \leq 1$ for $t \geq 0$. The second inequality implies that

$$\frac{d}{dt} V(x_{cl}(t)) + \lambda V(x_{cl}(t)) - \mu w_j(t)^T w_j(t) \leq 0. \quad (19)$$

Hence $(d/dt)V(x_{cl}(t)) \leq 0$ holds whenever $V(x_{cl}(t)) \geq \mu/\lambda$. Since $V(x_{cl}(0)) = 0$, this shows that $V(x_{cl}(t))$ cannot exceed the value μ/λ

$$V(x_{cl}(t)) \leq \frac{\mu}{\lambda}, \quad \text{for } t \geq 0. \quad (20)$$

To derive a bound on $\|T_j\|_{\text{peak}}$, it now suffices to bound $z_j(t)$ in terms of $V(x_{cl}(t))$ and $w_j(t)$, which is achieved through the third inequality in (18). Indeed, this inequality gives

$$\frac{1}{\zeta} \begin{pmatrix} \mathcal{C}_j^T \\ \mathcal{D}_j^T \end{pmatrix} (\mathcal{C}_j \quad \mathcal{D}_j) < \begin{pmatrix} \lambda \mathcal{P} & 0 \\ 0 & (\zeta - \mu)I \end{pmatrix}$$

and thus

$$\begin{aligned} z_j(t)^T z_j(t) &\ll \zeta (\lambda V(x_{cl}(t)) + (\zeta - \mu) w_j(t)^T w_j(t)) \\ &\leq \zeta (\lambda V(x_{cl}(t)) + (\zeta - \mu)). \end{aligned}$$

Recalling from (20) that $\lambda V(x_{cl}(t)) - \mu \leq 0$, this yields $z_j(t)^T z_j(t) \ll \zeta^2$. Summing up, (18) secures the stability of \mathcal{A} and the bound

$$\|T_j\|_{\text{peak}} < \zeta.$$

Note that (18) is only linear if fixing λ . Finding the best bound guaranteed by (18) hence requires performing a line-search over $\lambda > 0$. The implications for synthesis are clarified in Section V-E. For the purpose of the analysis, we observe that we can confine the search to $\lambda \in (0, -2 \max \text{Re}(\sigma(\mathcal{A})))$ (with $\sigma(\mathcal{A})$ as the set of eigenvalues of \mathcal{A}) since this is obviously implied by $\mathcal{A}^T \mathcal{P} + \mathcal{P} \mathcal{A} + \lambda \mathcal{P} < 0$.

Finally, we remark that (18) can be fairly conservative, especially when the system has slow or lightly damped modes that are weakly connected to the output $z_j(t)$. Also, the peak-to-peak gain may be a poor estimate of the overshoot of the step response.

G. Regional Pole Constraints

Pole assignment in convex regions of the left-half plane can also be expressed as LMI constraints on the Lyapunov matrix \mathcal{P} . To this end, a useful tool is the notion of the LMI region introduced in [11]. An LMI region is any region \mathcal{R} of the complex plane that can be defined as

$$\mathcal{R} = \{z \in \mathbf{C} : L + zM + \bar{z}M^T < 0\} \quad (21)$$

where $L = L^T$ and M are fixed real matrices. Note that \mathcal{R} is a convex region in the complex plane. Special cases include vertical strips, disks, horizontal strips, conic sectors, ellipsoids, parabolas, and arbitrary intersections thereof (see [11] for details).

The standard Lyapunov theorem for the open left-half plane $\{z : z + \bar{z} < 0\}$ can be generalized to arbitrary LMI regions. Specifically, a matrix \mathcal{A} has all its eigenvalues in the LMI region \mathcal{R} if and only if some LMI involving \mathcal{A} is solvable. This result makes LMI regions particularly appealing for synthesis purposes.

Theorem 2 [11]: The matrix \mathcal{A} has all its eigenvalues in the LMI region $\{z \in \mathbf{C} : [l_{ij} + m_{ij}z + m_{ji}\bar{z}]_{i,j} < 0\}$ if and only if there exists a symmetric \mathcal{P} such that

$$[l_{ij}\mathcal{P} + m_{ij}\mathcal{A}^T\mathcal{P} + m_{ji}\mathcal{P}\mathcal{A}]_{i,j} < 0, \quad \mathcal{P} > 0. \quad (22)$$

H. Nominal Regulation

We say that a controller *achieves nominal regulation* if it is stabilizing and if $\lim_{t \rightarrow \infty} z_j(t) = 0$ holds for all signals $w_j(\cdot)$ in the set

$$\{w_j(\cdot) \mid \dot{w}_j(t) = S w_j(t)\}. \quad (23)$$

This can be interpreted as asymptotically rejecting the disturbance $w = R_j w_j$ from $z_j = L_j z$ or, equivalently, letting $C_j x + E_j u$ track $-D_j w_j$ asymptotically. The matrix S is called the signal generator.

We want to apply the results of [14] that have been formulated under the following hypotheses:

$$\begin{aligned} (C_j \quad D_j \quad E_j) &= (C \quad F_j \quad 0), \quad \sigma(S) \subset \mathbf{C}^0 \cup \mathbf{C}^+ \\ \begin{pmatrix} A & B_j \\ 0 & S \\ C & F_j \end{pmatrix} &\text{ is detectable.} \end{aligned}$$

The first condition states that the controlled output signal z_j for this performance specification is identical to the measured signal y . Since any regulating controller is stabilizing, we can dispense with decaying signals which motivate the second property. If the third hypothesis does not hold, one can in fact reduce the signal generator to arrive at this property without causing loss of generality. Now we are ready to provide the solution to the nominal regulation problem as it can be extracted from [14].

Theorem 3: There exists a controller which achieves nominal regulation iff the linear equation

$$\begin{pmatrix} A & B \\ C & 0 \end{pmatrix} \begin{pmatrix} U \\ V \end{pmatrix} - \begin{pmatrix} U \\ 0 \end{pmatrix} S = \begin{pmatrix} B_j \\ F_j \end{pmatrix} \quad (24)$$

has solutions \mathbf{U}, \mathbf{V} . A controller achieves regulation iff it has a realization

$$u = \left[\begin{array}{cc|c} S & C_{K2} & D_{K2} \\ 0 & A_K & B_K \\ \hline \mathbf{V} & C_{K1} & D_{K1} \end{array} \right] y \quad (25)$$

where \mathbf{V} satisfies (24) (for some \mathbf{U}) and $A_K, B_K, C_{K1}, C_{K2}, D_{K1}$, and D_{K2} are such that the system

$$\begin{pmatrix} v_1 \\ v_2 \end{pmatrix} = \left[\begin{array}{cc|c} A_K & B_K \\ C_{K1} & D_{K1} \\ C_{K2} & D_{K2} \end{array} \right] y \quad (26)$$

stabilizes the extended plant

$$\begin{pmatrix} z \\ y \end{pmatrix} = \left[\begin{array}{cc|ccc} A & BV & B_w & B & 0 \\ 0 & S & 0 & 0 & I \\ \hline C_z & D_z \mathbf{V} & D_{zw} & D_z & 0 \\ C & 0 & D_w & 0 & 0 \end{array} \right] \begin{pmatrix} w \\ v_1 \\ v_2 \end{pmatrix}. \quad (27)$$

Remark 4: Note that (25) can be factorized as

$$u = \left[\begin{array}{c|cc} S & 0 & I \\ \hline \mathbf{V} & I & 0 \end{array} \right] \begin{pmatrix} v_1 \\ v_2 \end{pmatrix}, \quad \begin{pmatrix} v_1 \\ v_2 \end{pmatrix} = \left[\begin{array}{cc|c} A_K & B_K \\ C_{K1} & D_{K1} \\ C_{K2} & D_{K2} \end{array} \right] y$$

and that (27) is nothing but the original system precompensated by

$$u = \left[\begin{array}{c|cc} S & 0 & I \\ \hline \mathbf{V} & I & 0 \end{array} \right] \begin{pmatrix} v_1 \\ v_2 \end{pmatrix}.$$

1. Robust Regulation

In many problems it is important to keep up the regulation requirement in the face of uncertainties affecting the plant. The controller achieves *robust regulation* if it achieves nominal regulation (as defined in the last section), even after slightly perturbing the matrices describing the original system [12]. Classical results about robust regulation apply if

$$\begin{aligned} (C_j \ D_j \ E_j) &= L(C \ F_j \ 0), \quad L \text{ of full row rank} \\ \sigma(S) &\subset \mathbf{C}^0 \cup \mathbf{C}^+. \end{aligned} \quad (28)$$

The first condition implies that the controlled output signal z_j is a linear function $L_j y$ of the measured output, and the second one can be made since decaying signals are automatically regulated if the system is stabilized.

By the internal model principle, any robust regulator must contain a replica of the signal generator dynamics that can be constructed as follows. Let l be the number of rows of L , let $\alpha_j + i\beta_j$, $j = 1, \dots, s$, be the list of all pairwise different eigenvalues of S with nonnegative imaginary part, and denote by s_j the size of the largest Jordan block corresponding to $\alpha_j + i\beta_j$. Then define the internal model (\tilde{S}, \tilde{R}) as follows.

- If $\beta_j > 0$, set $U_j := \begin{pmatrix} \alpha_j I_l & -\beta_j I_l \\ \beta_j I_l & \alpha_j I_l \end{pmatrix}$, $V_j = \begin{pmatrix} I_l & 0 \\ 0 & I_l \end{pmatrix}$, $W_j = \begin{pmatrix} 0 \\ I_l \end{pmatrix}$.
- If $\beta_j = 0$, set $U_j := \alpha_j I_l$, $V_j = I_l$, $W_j = I_l$.

Then, define

$$\begin{aligned} \tilde{S}_j &:= \begin{pmatrix} U_j & V_j & 0 & \dots & 0 \\ 0 & U_j & V_j & \dots & 0 \\ \vdots & & \ddots & \ddots & \vdots \\ 0 & \dots & 0 & U_j & V_j \\ 0 & \dots & 0 & 0 & U_j \end{pmatrix} \\ \tilde{R}_j &= \begin{pmatrix} 0 \\ 0 \\ \vdots \\ 0 \\ W_j \end{pmatrix}, \quad \tilde{S} = \text{diag}(S_1, \dots, S_s) \\ \tilde{R} &= \begin{pmatrix} \tilde{R}_1 \\ \vdots \\ \tilde{R}_s \end{pmatrix} \end{aligned}$$

where \tilde{S}_j is square and \tilde{S}_j, \tilde{R}_j have s_j block rows.

Then we arrive at the following classical result [12].

Theorem 5: There exists a controller which achieves robust regulation iff

$$\begin{pmatrix} A - (\alpha_j + i\beta_j)I & B \\ LC & 0 \end{pmatrix} \text{ has full row rank} \\ \text{for all } j = 1, \dots, s.$$

A controller achieves robust regulation iff it has a realization

$$u = \left[\begin{array}{cc|c} A_K & B_{K1} & B_{K2} \\ 0 & \tilde{S} & \tilde{R}L \\ \hline C_K & D_{K1} & D_{K2} \end{array} \right] y \quad (29)$$

where $A_K, B_{K1}, B_{K2}, C_K, D_{K1}$, and D_{K2} are such that the system

$$u = \left[\begin{array}{c|cc} A_K & B_{K1} & B_{K2} \\ \hline C_K & D_{K1} & D_{K2} \end{array} \right] \begin{pmatrix} v \\ y \end{pmatrix} \quad (30)$$

stabilizes the extended plant

$$\begin{pmatrix} z \\ v \\ y \end{pmatrix} = \left[\begin{array}{cc|ccc} A & 0 & B_w & B & \\ \tilde{R}LC & \tilde{S} & \tilde{R}LD_w & 0 & \\ \hline C_z & 0 & D_{zw} & D_z & \\ 0 & I & 0 & 0 & \\ C & 0 & D_w & 0 & \end{array} \right] \begin{pmatrix} w \\ u \end{pmatrix}. \quad (31)$$

Remark 6: Now, regulator (29) can be factorized as

$$\begin{aligned} u &= \left[\begin{array}{c|cc} A_K & B_{K1} & B_{K2} \\ \hline C_K & D_{K1} & D_{K2} \end{array} \right] \begin{pmatrix} v \\ y \end{pmatrix} \\ v &= \left[\begin{array}{c|c} \tilde{S} & \tilde{R}L \\ \hline I & 0 \end{array} \right] y \end{aligned}$$

and (31) is nothing but the original system postcompensated by

$$v = \left[\begin{array}{c|c} \tilde{S} & \tilde{R}L \\ \hline I & 0 \end{array} \right] y.$$

In contrast to the nominal regulation problem, the internal model is hence put at the output of the system to arrive at the extended system (31).

In [12] this result is stated with the following modification: replace \tilde{R} by an (varying) R such that (\tilde{S}, R) is controllable. Hence, as an additional ingredient, we claim that one can fix R to \tilde{R} without loss of generality. Indeed, it is not difficult to show the following algebraic fact: for any R such that (\tilde{S}, R) is controllable, there exists a nonsingular T with $T^{-1}\tilde{S}T = \tilde{S}$ and $T^{-1}R = \tilde{R}$. Hence, if R differs from \tilde{R} , we just need to perform a state coordinate change in the controller to transform R back to \tilde{R} .

IV. LMI APPROACH TO MULTIOBJECTIVE SYNTHESIS

In the previous section, several time- and frequency-domain specifications have been expressed as LMI constraints on the closed-loop state-space matrices and Lyapunov functions. These analyses' results are now used for multiobjective synthesis purposes. We begin by formalizing the underlying principle and discussing its merits and limitations. We then propose a systematic procedure to turn analysis results into LMI constraints on the synthesis variables. This procedure relies on a simple change of controller variables to map all LMI's of Section III into a set of affine constraints on the new controller variables and the closed-loop Lyapunov function.

A. Lyapunov Shaping Paradigm

Our goal is to compute a single LTI controller K that: 1) internally stabilizes the closed-loop and 2) meets certain specifications on a particular set of channels. The specifications under consideration are those listed in Section III. For each specification, we have an analysis result of the form:

T_j satisfies the specification \mathcal{S}_j if there exists a Lyapunov matrix $\mathcal{P}_j > 0$ that satisfies some given LMI in \mathcal{P}_j .

Suppose that our synthesis problem involves N specifications $\mathcal{S}_1, \dots, \mathcal{S}_N$ (without restriction on which channel they apply). When gathering the LMI formulation of each specification \mathcal{S}_j , we end up with a set of matrix inequalities whose variables are:

- the controller matrices A_K, B_K, C_K, D_K ;
- the N Lyapunov matrices $\mathcal{P}_1, \dots, \mathcal{P}_N$ (one per specification);
- additional auxiliary variables such as Q (H_2 norm), λ, μ (peak-to-peak norm), and \mathbf{V} (nominal regulation).

Since expressions like $A^T \mathcal{P}_j + \mathcal{P}_j A$ involve products of \mathcal{P}_j and the controller variables, the resulting feasibility problem is nonlinear. Hence, it cannot be handled by LMI optimization and does not seem easily tractable numerically.

To recover convexity, we must require that all specifications are enforced by a *single* closed-loop Lyapunov function $V(x_{cl}) = x_{cl}^T \mathcal{P} x_{cl}$ with $\mathcal{P} > 0$. This amounts to imposing the constraint

$$\mathcal{P}_1 = \dots = \mathcal{P}_N = \mathcal{P}. \quad (32)$$

This restriction has been extensively used in the state-feedback case [6], [9] and in previous work on mixed H_2/H_∞ synthesis [5], [22]. With (32) in force, all inequalities can be further

reduced to LMI's *without additional conservatism* as shown below.

Before moving to the LMI solution of this simplified problem, we make a few comments on the implications of (32). Clearly, this restriction is stringent and brings conservatism into the design. Nevertheless, the resulting synthesis technique has valuable merits over existing alternatives. First, it is numerically tractable since it leads to an LMI problem. Second, it produces controllers of reasonable order. Finally, it exploits all degrees of freedom in \mathcal{P} . Specifically, the Lyapunov matrix \mathcal{P} is *shaped* by LMI optimization until either all specifications are met or all degrees of freedom are exhausted.

This Lyapunov shaping paradigm offers greater flexibility than standard "optimal" design techniques. For instance, suppose that we need to minimize the H_2 norm on one channel, subject to some moderate H_∞ performance requirement on another channel. While there may be a large set of Lyapunov matrices \mathcal{P} compatible with the specified H_∞ performance, H_∞ -synthesis techniques based on Riccati equations are unable to exploit these additional degrees of freedom and may return a solution with poor H_2 performance or unacceptably fast controller dynamics. In contrast, multiobjective LMI synthesis will use these degrees of freedom to optimize the H_2 performance or pole location. Thus our approach, while conservative, is nonetheless an improvement over classical synthesis techniques and a valuable tool to fine-tune complex designs.

B. Linearizing Change of Variable

In the state-feedback case, the simplification (32) makes all inequalities affine in \mathcal{P}^{-1} and $F\mathcal{P}^{-1}$, where F is the state-feedback gain to be determined. It then only takes the change of variables $\mathbf{X} = \mathcal{P}^{-1}$, $\mathbf{F} = F\mathcal{P}^{-1}$ to turn all constraints into LMI's. A similar approach was long believed beyond reach in the output-feedback case. However, recent results [11], [24], [30] have proved otherwise. This critical change of variables is defined next. Note that we use boldface letters to emphasize the LMI optimization variables.

Let n be the number of states of the plant (size of A), and let k be the order of the controller. Partition \mathcal{P} and \mathcal{P}^{-1} as

$$\mathcal{P} = \begin{pmatrix} \mathbf{Y} & N \\ N^T & \star \end{pmatrix}, \quad \mathcal{P}^{-1} = \begin{pmatrix} \mathbf{X} & M \\ M^T & \star \end{pmatrix} \quad (33)$$

where \mathbf{X} and \mathbf{Y} are $n \times n$ and symmetric. From $\mathcal{P}\mathcal{P}^{-1} = I$, we infer $\mathcal{P} \begin{pmatrix} \mathbf{X} \\ M^T \end{pmatrix} = \begin{pmatrix} I \\ 0 \end{pmatrix}$ which leads to

$$\begin{aligned} \mathcal{P}\Pi_1 &= \Pi_2 \text{ with } \Pi_1 := \begin{pmatrix} \mathbf{X} & I \\ M^T & 0 \end{pmatrix} \\ \Pi_2 &:= \begin{pmatrix} I & \mathbf{Y} \\ 0 & N^T \end{pmatrix}. \end{aligned} \quad (34)$$

Let us now define the change of controller variables as follows:

$$\begin{cases} \hat{\mathbf{A}} := N A_K M^T + N B_K C X + Y B C_K M^T \\ \quad + Y (A + B D_K C) X \\ \hat{\mathbf{B}} := N B_K + Y B D_K \\ \hat{\mathbf{C}} := C_K M^T + D_K C X \\ \hat{\mathbf{D}} := D_K. \end{cases} \quad (35)$$

Note that the new variables $\hat{\mathbf{A}}, \hat{\mathbf{B}}, \hat{\mathbf{C}}$ have dimensions $n \times n$, $n \times n_u$, and $n_y \times n$, respectively. If M and N have full row rank, and if $\hat{\mathbf{A}}, \hat{\mathbf{B}}, \hat{\mathbf{C}}, \hat{\mathbf{D}}, \mathbf{X}$, and \mathbf{Y} are given, we can always compute controller matrices A_K, B_K, C_K, D_K satisfying (35). If M and N are square ($k = n$) and invertible matrices, then A_K, B_K, C_K , and D_K are unique. For full-order design, one can always assume that M and N have full row rank. Hence the variables A_K, B_K, C_K, D_K can be replaced by $\hat{\mathbf{A}}, \hat{\mathbf{B}}, \hat{\mathbf{C}}, \hat{\mathbf{D}}$ without loss of generality. Note that this same change of variables was already used in [17] in the context of pure H_∞ control and in [11] and [30] for special cases of the general multiobjective problem discussed in this paper.

The motivation for this transformation lies in the following identities derived from (34) and (35) after a short calculation:

$$\begin{aligned} \Pi_1^T \mathcal{P} \Pi_1 &= \Pi_2^T \mathcal{A} \Pi_1 = \begin{pmatrix} \mathbf{A}\mathbf{X} + \mathbf{B}\hat{\mathbf{C}} & \mathbf{A} + \mathbf{B}\hat{\mathbf{D}}\mathbf{C} \\ \hat{\mathbf{A}} & \mathbf{Y}\mathbf{A} + \hat{\mathbf{B}}\mathbf{C} \end{pmatrix} \\ \Pi_1^T \mathcal{P} \mathcal{B}_j &= \Pi_2^T \mathcal{B}_j = \begin{pmatrix} \mathbf{B}_j + \mathbf{B}\hat{\mathbf{D}}\mathbf{F}_j \\ \mathbf{Y}\mathbf{B}_j + \hat{\mathbf{B}}\mathbf{F}_j \end{pmatrix} \\ \mathcal{C}_j \Pi_1 &= (\mathcal{C}_j \mathbf{X} + \mathbf{E}_j \hat{\mathbf{C}} \quad \mathcal{C}_j + \mathbf{E}_j \hat{\mathbf{D}}\mathbf{C}) \\ \Pi_1^T \mathcal{P} \Pi_1 &= \Pi_1^T \Pi_2 = \begin{pmatrix} \mathbf{X} & \mathbf{I} \\ \mathbf{I} & \mathbf{Y} \end{pmatrix}. \end{aligned} \quad (36)$$

In light of these identities, we are ready to show how synthesis LMI's can be derived from the analysis results of Section III via a suitable congruence transformation. A detailed proof is given only for the generalized H_2 problem.

Fix $\alpha > 0$ and suppose that (16) holds for some $\mathcal{P} > 0$ and some controller with realization (A_K, B_K, C_K, D_K) . We can assume without loss of generality that this controller is of order at least n and that M and N in (33) have full row rank (see [17] for details). By (34), and since \mathcal{P} is nonsingular, Π_1 has full column rank. If we perform a congruence transformation with $\text{diag}(\Pi_1, I)$ on both inequalities (16), we obtain

$$\begin{pmatrix} \Pi_1^T \mathcal{A}^T \mathcal{P} \Pi_1 + \Pi_1^T \mathcal{P} \Pi_1 & \Pi_1^T \mathcal{P} \mathcal{B}_j \\ \mathcal{B}_j^T \mathcal{P} \Pi_1 & -I \end{pmatrix} < 0 \\ \begin{pmatrix} \Pi_1^T \mathcal{P} \Pi_1 & \Pi_1^T \mathcal{C}_j^T \\ \mathcal{C}_j \Pi_1 & \alpha I \end{pmatrix} > 0. \end{pmatrix} \quad (37)$$

Now we just need to replace $\Pi_1^T \mathcal{P} \Pi_1$, $\Pi_1^T \mathcal{P} \mathcal{B}_j$, $\mathcal{C}_j \Pi_1$, and $\Pi_1^T \mathcal{P} \Pi_1$ by their explicit expressions (36) to arrive at (38), shown at the bottom of the page. These inequalities/equations are clearly affine in $\hat{\mathbf{A}}, \hat{\mathbf{B}}, \hat{\mathbf{C}}, \hat{\mathbf{D}}, \mathbf{X}, \mathbf{Y}$. Thus we have proved that the solvability of these LMI's is *necessary* for the existence of a stabilizing controller rendering $\|T\|_g^2 < \alpha$.

Let us now reverse the argument and assume that we have found solutions to the LMI's (38). First we need to construct

M, N , and \mathcal{P} that satisfy (34). Looking at the left upper block of $\mathcal{P} \Pi_1 = \Pi_2$, M and N should be chosen such that

$$MN^T = I - \mathbf{X}\mathbf{Y}. \quad (39)$$

By $\begin{pmatrix} \mathbf{X} & \mathbf{I} \\ \mathbf{I} & \mathbf{Y} \end{pmatrix} > 0$, we infer $\mathbf{Y} > 0$, $\mathbf{X} - \mathbf{Y}^{-1} > 0$ such that $I - \mathbf{X}\mathbf{Y}$ is nonsingular. Hence, one can always find square and nonsingular M and N satisfying (39). After defining Π_1, Π_2 as in (34), we observe that these matrices are nonsingular, and we can set $\mathcal{P} := \Pi_2 \Pi_1^{-1}$ to obtain (34). Since M and N are nonsingular, (35) can be solved for D_K, C_K, B_K , and A_K in this order. Since (34) and (35) imply (36), we know that (37) and (38) are identical. Recalling that Π_1 is square and nonsingular, we can reverse the congruence transformation with $\text{diag}(\Pi_1, I)$ to obtain (16) from (37). Hence the constructed controller indeed leads to $\|T_j\|_g^2 < \alpha$.

Let us finally observe that the synthesis LMI's are also affine in α . Hence, minimizing α subject to the LMI constraints (38) is also an LMI problem. For the controller computation, however, one should keep in mind that $I - \mathbf{X}\mathbf{Y}$ ought to be well conditioned to avoid ill-conditioned inversions of the matrices M and N . Unfortunately, $I - \mathbf{X}\mathbf{Y}$ will be nearly singular if the constraint (41) is saturated at the optimum. To avoid such difficulties, we advise the following remedy: choose some nearly optimal value of α , and include the LMI

$$\begin{pmatrix} \mathbf{X} & t\mathbf{I} \\ t\mathbf{I} & \mathbf{Y} \end{pmatrix} > 0$$

with the additional variable t and maximize t . This procedure maximizes the minimal eigenvalue of $\mathbf{X}\mathbf{Y}$ and, hence, pushes it away from one such that $I - \mathbf{X}\mathbf{Y}$ is expected to be well conditioned.

C. Synthesis LMI's and Controller Computation

The discussion of the last section allows us to extract a recipe for getting to an LMI synthesis result on the basis of an LMI analysis result: suppose the analysis result is formulated in terms of LMI's in the blocks $\mathcal{P}, \mathcal{P}\mathcal{A}, \mathcal{P}\mathcal{B}_j, \mathcal{C}_j, \mathcal{D}_j$, and their transposes, and suppose one can find congruence transformations of these LMI's that involve the block Π_1 and that transform the original LMI's into LMI's in the blocks $\Pi_1^T \mathcal{P} \Pi_1, \Pi_1^T \mathcal{P} \Pi_1, \Pi_1^T \mathcal{P} \mathcal{B}_j, \mathcal{C}_j \Pi_1, \mathcal{D}_j$ and their transposes. If one substitutes all the appearing blocks by the formulas (36), one arrives at the corresponding synthesis LMI's in $\hat{\mathbf{A}}, \hat{\mathbf{B}}, \hat{\mathbf{C}}, \hat{\mathbf{D}}, \mathbf{X}, \mathbf{Y}$ and possible auxiliary variables. After solving the synthesis LMI's, the controller construction proceeds as follows: find nonsingular matrices M, N to satisfy

$$\begin{pmatrix} \mathbf{A}\mathbf{X} + \mathbf{X}\mathbf{A}^T + \mathbf{B}\hat{\mathbf{C}} + (\mathbf{B}\hat{\mathbf{C}})^T & \hat{\mathbf{A}}^T + (\mathbf{A} + \mathbf{B}\hat{\mathbf{D}}\mathbf{C}) & \mathbf{B}_j + \mathbf{B}\hat{\mathbf{D}}\mathbf{F}_j \\ \hat{\mathbf{A}} + (\mathbf{A} + \mathbf{B}\hat{\mathbf{D}}\mathbf{C})^T & \mathbf{A}^T \mathbf{Y} + \mathbf{Y}\mathbf{A} + \hat{\mathbf{B}}\mathbf{C} + (\hat{\mathbf{B}}\mathbf{C})^T & \mathbf{Y}\mathbf{B}_j + \hat{\mathbf{B}}\mathbf{F}_j \\ (\mathbf{B}_j + \mathbf{B}\hat{\mathbf{D}}\mathbf{F}_j)^T & (\mathbf{Y}\mathbf{B}_j + \hat{\mathbf{B}}\mathbf{F}_j)^T & -I \end{pmatrix} < 0 \\ \begin{pmatrix} \mathbf{X} & \mathbf{I} & (\mathcal{C}_j \mathbf{X} + \mathbf{E}_j \hat{\mathbf{C}})^T \\ \mathbf{I} & \mathbf{Y} & (\mathcal{C}_j + \mathbf{E}_j \hat{\mathbf{D}}\mathbf{C})^T \\ \mathcal{C}_j \mathbf{X} + \mathbf{E}_j \hat{\mathbf{C}} & \mathcal{C}_j + \mathbf{E}_j \hat{\mathbf{D}}\mathbf{C} & \alpha I \end{pmatrix} > 0, \quad \mathcal{D}_j + \mathbf{E}_j \hat{\mathbf{D}}\mathbf{F}_j = 0 \quad (38)$$

$MN^T = I - \mathbf{X}\mathbf{Y}$ and define the controller by

$$\begin{cases} D_K := \hat{D} \\ C_K := (\hat{C} - D_K C \mathbf{X}) M^{-T} \\ B_K := N^{-1}(\hat{B} - \mathbf{Y} B D_K) \\ A_K := N^{-1}(\hat{A} - N B_K C \mathbf{X} - \mathbf{Y} B C_K M^T \\ \quad - \mathbf{Y}(A + B D_K C) \mathbf{X}) M^{-T}. \end{cases} \quad (40)$$

$$\begin{pmatrix} \mathbf{X} & I \\ I & \mathbf{Y} \end{pmatrix} > 0 \quad (41)$$

This gives a formal description of all problems to which we can apply the controller parameter transformation in order to obtain the synthesis LMI's. The proof is literally the same as for the generalized H_2 problem discussed in Section IV-B. Note that the necessity part of the proof does not restrict the order of the controller and that the construction in the sufficiency part leads to a controller that is of the same order as the plant. Finally, we stress that this procedure does not introduce any conservatism: if the analysis result does not involve conservatism, the synthesis result does neither. If combining several of these specification into a multiobjective design, additional conservatism is only introduced through using a common Lyapunov function, at the benefit of being able to restrict the order of the controller to that of the plant.

For nominal and robust regulation, we need a slight modification of this procedure that is discussed in Section V-G.

V. A CATALOG OF LMI'S FOR FULL-ORDER SYNTHESIS

For completeness, this section lists the synthesis LMI's attached to each specification or objective considered in Section III. These synthesis LMI's are readily derived from the analysis results of Section III by applying the systematic procedure described in Section IV-B. No new proof is required to justify these results, the proof in IV-B being generic. This section is meant as a catalog where one can easily find the appropriate LMI formulation for each particular specification. For instance, suppose that the design problem involves an H_∞ constraint on channel one, an H_2 constraint on channel two, and a regional pole placement constraint. One would then find the corresponding synthesis LMI's on the list below, gather them in a single system of LMI's, and solve this LMI system numerically to derive a solution of the multiobjective problem under consideration.

Since the requirement $\mathcal{P} > 0$ is common to all analysis results of Section III, the constraint

should always be included in the list of synthesis LMI's, either explicitly or as part of some other LMI constraint [see, e.g., the second LMI in (38)].

A. H_∞ Synthesis

The analysis LMI's (8) are transformed with Π_1 and $\text{diag}(\Pi_1, I, I)$. Then, (36) leads to the synthesis LMI as in (42), shown at the bottom of the page, where * replaces blocks that are readily inferred by symmetry. Since γ enters linearly, it can be directly minimized by LMI optimization to find the smallest achievable H_∞ norm. As a single objective problem, no conservatism is involved. Imposing independent H_∞ constraints on several different channels just amounts to incorporating (42) for each individual channel and introduces conservatism.

B. General Quadratic Constraints

With the congruence transformations Π_1 and $\text{diag}(\Pi_1, I, I)$, we obtain the synthesis LMI given in (43), also shown at the bottom of the page, where (1, 1), (1, 2), and (2, 2) refer to the corresponding blocks in (42). Instead of fixing V_j and Σ_j , we can allow some free parameters in these matrices. Then, it is clearly possible to minimize or maximize a linear function in these free parameters. The synthesis LMI's for designing a strictly passive system are obtained by just setting $Q_j = 0$, $\Sigma_j = I$, $V_j = 0$, $W_j = -I$ (such that the fourth block row and column can be canceled); this extends [31] to general systems. Again, at the expense of conservatism, we can include as many quadratic constraints on different channels as desired.

C. H_2 and Generalized H_2 Synthesis

The synthesis LMI's for generalized H_2 control have been given in (38). With the same congruence transformation $\text{diag}(\Pi_1, I)$, we obtain from the analysis LMI's (14) for the standard H_2 problem the synthesis LMI's, as in (v), shown at the bottom of the next page.

$$\begin{pmatrix} \mathbf{A}\mathbf{X} + \mathbf{X}\mathbf{A}^T + \mathbf{B}\hat{\mathbf{C}} + (\mathbf{B}\hat{\mathbf{C}})^T & \hat{\mathbf{A}}^T + (\mathbf{A} + \mathbf{B}\hat{\mathbf{D}}\mathbf{C}) & * & * \\ \hat{\mathbf{A}} + (\mathbf{A} + \mathbf{B}\hat{\mathbf{D}}\mathbf{C})^T & \mathbf{A}^T\mathbf{Y} + \mathbf{Y}\mathbf{A} + \hat{\mathbf{B}}\mathbf{C} + (\hat{\mathbf{B}}\mathbf{C})^T & * & * \\ (\mathbf{B}_j + \mathbf{B}\hat{\mathbf{D}}\mathbf{F}_j)^T & (\mathbf{Y}\mathbf{B}_j + \hat{\mathbf{B}}\mathbf{F}_j)^T & -\gamma\mathbf{I} & * \\ \mathbf{C}_j\mathbf{X} + \mathbf{E}_j\hat{\mathbf{C}} & \mathbf{C}_j + \mathbf{E}_j\hat{\mathbf{D}}\mathbf{C} & \mathbf{D}_j + \mathbf{E}_j\hat{\mathbf{D}}\mathbf{F}_j & -\gamma\mathbf{I} \end{pmatrix} < 0 \quad (42)$$

$$\begin{pmatrix} (1, 1) & (1, 2) & (\mathbf{B}_j + \mathbf{B}\hat{\mathbf{D}}\mathbf{F}_j) + (\mathbf{C}_j\mathbf{X} + \mathbf{E}_j\hat{\mathbf{C}})^T\mathbf{W}_j & (\mathbf{C}_j\mathbf{X} + \mathbf{E}_j\hat{\mathbf{C}})^T\mathbf{Q}_j \\ * & (2, 2) & (\mathbf{Y}\mathbf{B}_j + \hat{\mathbf{B}}\mathbf{F}_j) + (\mathbf{C}_j + \mathbf{E}_j\hat{\mathbf{D}}\mathbf{C})^T\mathbf{W}_j & (\mathbf{C}_j + \mathbf{E}_j\hat{\mathbf{D}}\mathbf{C})^T\mathbf{Q}_j \\ * & * & \mathbf{V}_j + \mathbf{W}_j^T(\mathbf{D}_j + \mathbf{E}_j\hat{\mathbf{D}}\mathbf{F}_j) + (\mathbf{D}_j + \mathbf{E}_j\hat{\mathbf{D}}\mathbf{F}_j)^T\mathbf{W}_j & (\mathbf{D}_j + \mathbf{E}_j\hat{\mathbf{D}}\mathbf{F}_j)^T\mathbf{Q}_j \\ * & * & * & -\Sigma_j \end{pmatrix} < 0 \quad (43)$$

These involve the auxiliary variables Q and ν which enter linearly. Hence, ν can be directly minimized by LMI optimization. Note that synthesis results for a variety of generalized H_2 criteria can be derived by simply replacing $\text{Tr}(Q)$ with any affine function $f(Q)$ mapping symmetric matrices into symmetric matrices [30].

D. Synthesis for Bounds on Peak Impulse Response

The congruence transformations Π_1 and $\text{diag}(\Pi_1, I)$ transform (17) into $D_j + E_j \hat{D}F_j = 0$ and (w), shown at the bottom of the page. One can directly minimize the upper bound ξ on the peak impulse response. We stress again that even the single objective synthesis result involves conservatism since the analysis result does.

E. Synthesis with Bound on the Peak-to-Peak Gain

Using the congruence transformations $\text{diag}(\Pi_1, I)$, $\text{diag}(\Pi_1, I, I)$, one arrives at the following synthesis inequalities: $\lambda > 0$ and those in (44), shown at the bottom of the page. Note that the auxiliary variable λ enters nonlinearly. However, if we fix $\lambda > 0$, we can minimize ζ to obtain an infimal upper bound $\zeta_*(\lambda)$ of the peak-to-peak norm that clearly depends on λ . Hence, to improve this upper bound, we have to further minimize $\zeta_*(\lambda)$ over $\lambda > 0$, which involves solving a one-dimensional minimization problem.

F. Regional Pole Placement

The matrix $\text{diag}(\Pi_1, \dots, \Pi_1)$ transforms (22) to the LMI

$$\left(l_{jk} \begin{pmatrix} \mathbf{X} & I \\ I & \mathbf{Y} \end{pmatrix} + m_{jk} \begin{pmatrix} \mathbf{A}\mathbf{X} + \mathbf{B}\hat{\mathbf{C}} & \mathbf{A} + \mathbf{B}\hat{\mathbf{D}}\mathbf{C} \\ \hat{\mathbf{A}} & \mathbf{Y}\mathbf{A} + \hat{\mathbf{B}}\mathbf{C} \end{pmatrix}^T + m_{kj} \begin{pmatrix} \mathbf{A}\mathbf{X} + \mathbf{B}\hat{\mathbf{C}} & \mathbf{A} + \mathbf{B}\hat{\mathbf{D}}\mathbf{C} \\ \hat{\mathbf{A}} & \mathbf{Y}\mathbf{A} + \hat{\mathbf{B}}\mathbf{C} \end{pmatrix} \right)_{j,k} < 0. \quad (45)$$

We can include this inequality in any of the design problems discussed so far to enforce that the eigenvalues of \mathbf{A} (and hence the poles of the closed-loop system) are contained in the LMI region (21).

G. Nominal Regulation

Theorem 3 suggests the following procedure to design a controller that achieves regulation *and* leads to any of the specifications we have listed so far: test whether (24) is solvable. Then, try to achieve the desired specification with the controller (26) for the extended system (27) and some \mathbf{V} for which there exists a \mathbf{U} such that (24) holds.

The central technical difficulty in this procedure arises from the new unknown \mathbf{V} in the plant description (27) which we need to vary in a linear manifold determined by the solution set of (24). If (24) does not have a unique solution, there are free parameters that enter the synthesis inequalities nonlinearly. In general, such problems are hard to resolve. Due to the

$$\begin{pmatrix} \mathbf{A}\mathbf{X} + \mathbf{X}\mathbf{A}^T + \mathbf{B}\hat{\mathbf{C}} + (\mathbf{B}\hat{\mathbf{C}})^T & \hat{\mathbf{A}}^T + (\mathbf{A} + \mathbf{B}\hat{\mathbf{D}}\mathbf{C}) & \mathbf{B}_j + \mathbf{B}\hat{\mathbf{D}}\mathbf{F}_j \\ \hat{\mathbf{A}} + (\mathbf{A} + \mathbf{B}\hat{\mathbf{D}}\mathbf{C})^T & \mathbf{A}^T\mathbf{Y} + \mathbf{Y}\mathbf{A} + \hat{\mathbf{B}}\mathbf{C} + (\hat{\mathbf{B}}\mathbf{C})^T & \mathbf{Y}\mathbf{B}_j + \hat{\mathbf{B}}\mathbf{F}_j \\ (\mathbf{B}_j + \mathbf{B}\hat{\mathbf{D}}\mathbf{F}_j)^T & (\mathbf{Y}\mathbf{B}_j + \hat{\mathbf{B}}\mathbf{F}_j)^T & -I \end{pmatrix} < 0$$

$$\begin{pmatrix} \mathbf{X} & I & (\mathbf{C}_j\mathbf{X} + \mathbf{E}_j\hat{\mathbf{C}})^T \\ I & \mathbf{Y} & (\mathbf{C}_j + \mathbf{E}_j\hat{\mathbf{D}}\mathbf{C})^T \\ \mathbf{C}_j\mathbf{X} + \mathbf{E}_j\hat{\mathbf{C}} & \mathbf{C}_j + \mathbf{E}_j\hat{\mathbf{D}}\mathbf{C} & Q \end{pmatrix} > 0$$

$$\text{Tr}(Q) < \nu, \quad D_j + E_j \hat{D}F_j = 0 \quad (\text{v})$$

$$\begin{pmatrix} \mathbf{A}\mathbf{X} + \mathbf{X}\mathbf{A}^T + \mathbf{B}\hat{\mathbf{C}} + (\mathbf{B}\hat{\mathbf{C}})^T & \hat{\mathbf{A}}^T + (\mathbf{A} + \mathbf{B}\hat{\mathbf{D}}\mathbf{C}) \\ \hat{\mathbf{A}} + (\mathbf{A} + \mathbf{B}\hat{\mathbf{D}}\mathbf{C})^T & \mathbf{A}^T\mathbf{Y} + \mathbf{Y}\mathbf{A} + \hat{\mathbf{B}}\mathbf{C} + (\hat{\mathbf{B}}\mathbf{C})^T \end{pmatrix} < 0$$

$$\begin{pmatrix} \mathbf{X} & I & \mathbf{B}_j + \mathbf{B}\hat{\mathbf{D}}\mathbf{F}_j \\ I & \mathbf{Y} & \mathbf{Y}\mathbf{B}_j + \hat{\mathbf{B}}\mathbf{F}_j \\ (\mathbf{B}_j + \mathbf{B}\hat{\mathbf{D}}\mathbf{F}_j)^T & (\mathbf{Y}\mathbf{B}_j + \hat{\mathbf{B}}\mathbf{F}_j)^T & \xi I \end{pmatrix} > 0$$

$$\begin{pmatrix} \mathbf{X} & I & (\mathbf{C}_j\mathbf{X} + \mathbf{E}_j\hat{\mathbf{C}})^T \\ I & \mathbf{Y} & (\mathbf{C}_j + \mathbf{E}_j\hat{\mathbf{D}}\mathbf{C})^T \\ \mathbf{C}_j\mathbf{X} + \mathbf{E}_j\hat{\mathbf{C}} & \mathbf{C}_j + \mathbf{E}_j\hat{\mathbf{D}}\mathbf{C} & \xi I \end{pmatrix} > 0 \quad (\text{w})$$

$$\begin{pmatrix} \mathbf{A}\mathbf{X} + \mathbf{X}\mathbf{A}^T + \mathbf{B}\hat{\mathbf{C}} + (\mathbf{B}\hat{\mathbf{C}})^T + \lambda\mathbf{X} & * & * \\ \hat{\mathbf{A}} + (\mathbf{A} + \mathbf{B}\hat{\mathbf{D}}\mathbf{C})^T + \lambda I & \mathbf{A}^T\mathbf{Y} + \mathbf{Y}\mathbf{A} + \hat{\mathbf{B}}\mathbf{C} + (\hat{\mathbf{B}}\mathbf{C})^T + \lambda\mathbf{Y} & * \\ (\mathbf{B}_j + \mathbf{B}\hat{\mathbf{D}}\mathbf{F}_j)^T & (\mathbf{Y}\mathbf{B}_j + \hat{\mathbf{B}}\mathbf{F}_j)^T & -\mu I \end{pmatrix} < 0$$

$$\begin{pmatrix} \lambda\mathbf{X} & \lambda I & 0 & * \\ \lambda I & \lambda\mathbf{Y} & 0 & * \\ 0 & 0 & (\zeta - \mu)I & * \\ \mathbf{C}_j\mathbf{X} + \mathbf{E}_j\hat{\mathbf{C}} & \mathbf{C}_j + \mathbf{E}_j\hat{\mathbf{D}}\mathbf{C} & D_j + E_j \hat{D}F_j & \zeta I \end{pmatrix} > 0 \quad (44)$$

particular structural dependence, however, the present problem is fully tractable. Indeed, one has to work with a suitable modification of Π_1 to arrive at tractable LMI's. For this purpose we define

$$W_U := \begin{pmatrix} I & U \\ 0 & I \end{pmatrix}.$$

Then, one easily obtains

$$W_U^{-1} \begin{pmatrix} A & BV \\ 0 & S \end{pmatrix} W_U = \begin{pmatrix} A & B_j \\ 0 & S \end{pmatrix}$$

and

$$(C \ 0)W_U = (C \ F_j) \quad (46)$$

from (24). Let us modify Π_1 to

$$\Pi_U = \Pi_1 \begin{pmatrix} I & 0 \\ 0 & W_U \end{pmatrix} = \begin{pmatrix} X & W_U \\ M^T & 0 \end{pmatrix}$$

and consider the blocks (36) for the extended system (27) and with Π_1 replaced by Π_U . The block $\Pi_U^T \mathcal{P} \Pi_U$ is given by (x), shown at the bottom of the page. These formulas motivate the introduction of the new variables

$$\begin{aligned} \check{Y} &:= W_U^T Y W_U, & \check{A} &:= W_U^T \hat{A} \\ \check{B} &:= W_U^T \hat{B}, & \check{C} &:= \begin{pmatrix} 0 & V \\ 0 & 0 \end{pmatrix} X + \hat{C} \end{aligned} \quad (47)$$

and due to the nonsingularity of W_U , this is just another parameter transformation. If we exploit (46), we obtain (y), as shown at the bottom of the page. Obviously, all these blocks depend affinely on the variables $U, V, X, \check{Y}, \check{A}, \check{B}, \check{C}, \hat{D}$.

We arrive at the following procedure for performing multiobjective synthesis including nominal regulation: in any analysis LMI, substitute $\mathcal{P}, \mathcal{P}A, \mathcal{P}B_j, C_j$ by these new formulas [instead of those in (36)] and add the linear constraint (24) for the extra variables U, V . Test the resulting synthesis LMI's for solvability. With a solution, the controller is constructed

as follows: reverse (47) as

$$\begin{aligned} Y &= W_U^{-T} \check{Y} W_U^{-1}, & \hat{A} &= W_U^{-T} \check{A} \\ \hat{B} &= W_U^{-T} \check{B}, & \hat{C} &= \check{C} - \begin{pmatrix} 0 & V \\ 0 & 0 \end{pmatrix} X \end{aligned}$$

to obtain $U, V, X, Y, \hat{A}, \hat{B}, \hat{C}, \hat{D}$; find square M, N with $MN^T = I - XY$, and define the parameters A_K, B_K, C_K , and D_K as in (40) for the extended system (27); partition the rows of C_K and D_K as in (26); then, the desired controller is given as (25) and its order is bounded by the order of the plant (size of A_K) plus the size of S .

Note that this procedure does not introduce conservatism. For a single-objective specification with an exact LMI analysis/synthesis characterization, it leads to an exact solution of the corresponding problem with nominal regulation, and in the other cases, conservatism is only introduced through nonexact analysis tests or through the use of a common Lyapunov function for multiple objectives.

For nominal regulation, the most related results are found in [10], where a special H_∞ problem (for coprime factor uncertainty) is discussed under the hypothesis that (24) has a *unique* solution. Incorporating a general nominal regulation requirement [without hypothesis on (24)] in all the other single-objective or mixed problems are new design goals that found a complete solution.

H. Robust Regulation

Contrary to nominal regulation, the internal model and the extended system in Theorem 5 are fixed such that they pose no problem for including the requirement of robust regulation in any of the specifications listed so far without introducing extra conservatism. Build (31), solve the corresponding synthesis problems for this extended plant with a controller (30), and define the final controller by (29). Its order is bounded by that of the plant plus the size of \check{S} .

One can in fact prove that the controller (29) achieves regulation for *any* LTI system (1) for which (30) stabilizes (31). Suppose that (1) is affected by perturbations $w =$

$$\left(\begin{array}{cc} \begin{pmatrix} A & BV \\ 0 & S \end{pmatrix} X + \begin{pmatrix} B & 0 \\ 0 & I \end{pmatrix} \check{C} & \begin{pmatrix} A & BV \\ 0 & S \end{pmatrix} W_U + \begin{pmatrix} B & 0 \\ 0 & I \end{pmatrix} \hat{D} (C \ 0) W_U \\ W_U^T \hat{A} & W_U^T Y \begin{pmatrix} A & BV \\ 0 & S \end{pmatrix} W_U + W_U^T \hat{B} (C \ 0) W_U \end{array} \right) \quad (x)$$

$$\begin{aligned} \Pi_U^T \mathcal{P} \Pi_U &= \begin{pmatrix} \begin{pmatrix} A & 0 \\ 0 & S \end{pmatrix} X + \begin{pmatrix} B & 0 \\ 0 & I \end{pmatrix} \check{C} & \begin{pmatrix} A & AU + BV \\ 0 & S \end{pmatrix} + \begin{pmatrix} B & 0 \\ 0 & I \end{pmatrix} \hat{D} (C \ F_j) \\ & \hat{A} & \check{Y} \begin{pmatrix} A & B_j \\ 0 & S \end{pmatrix} + \check{B} (C \ F_j) \end{pmatrix} \\ \Pi_U^T \mathcal{P} \Pi_U &= \begin{pmatrix} X & \begin{pmatrix} I & U \\ 0 & I \end{pmatrix} \\ \begin{pmatrix} I & 0 \\ U^T & I \end{pmatrix} & \check{Y} \end{pmatrix}, & \Pi_U^T \mathcal{P} B_j &= \begin{pmatrix} \begin{pmatrix} B_j \\ 0 \end{pmatrix} + \begin{pmatrix} B & 0 \\ 0 & I \end{pmatrix} \hat{D} F_j \\ \check{Y} \begin{pmatrix} B_j \\ 0 \end{pmatrix} + \check{B} F_j, \end{pmatrix} \\ C_j \Pi_U &= ((C_j \ 0) X + (E_j \ 0) \check{C} \ (C_j \ C_j U + E_j V) + (E_j \ 0) \hat{D} (C \ F_j)) \end{aligned} \quad (y)$$

$R_j \Delta L_j z$ with a (stable) LTI Δ in some class $\mathbf{\Delta}$. Let us assume that one can design a controller (30) which robustly stabilizes (31) for this same class of uncertainties (e.g., by solving an H_∞ or passivity problem or any other robust stability specification given in our list). Then, the controller (29) achieves regulation for all perturbed systems (1), simply because (30) stabilizes all the perturbed extended systems (31). Hence, one can guarantee regulation for the (possibly large) class of uncertainties $\mathbf{\Delta}$, and this solves the problem of robust regulation in the large.

The present result extends those in [1] and [2] to signal generators that are not necessarily diagonalizable and to the variety of mixed problems considered in this paper.

VI. A REMARK ON REDUCED-ORDER CONTROLLERS

In all mixed problems discussed in this paper, the constructed controllers have the same dimension as the plant (possibly plus internal model in regulation). For completeness and only as a theoretical insight, we include a characterization for the existence of controllers that have dimension $n - k < n$. Let us assume w.l.o.g. that

$$\begin{pmatrix} B \\ D_z \end{pmatrix} \text{ and } \begin{pmatrix} C^T \\ D_w^T \end{pmatrix} \text{ have full column rank.} \quad (48)$$

To be specific we outline the result for the generalized H_2 problem.

Suppose a controller of dimension $n - k < n$ leads to (16). As earlier, we obtain (34) where the matrices M , N are of size $n \times (n - k)$ and can be assumed to have full column rank. Hence, Π_1 has a kernel of dimension k such that all the blocks $\Pi_1^T \mathcal{P} A \Pi_1$, $\Pi_1^T \mathcal{A}^T \mathcal{P} \Pi_1$, $\mathcal{B}_w^T \mathcal{P} \Pi_1$, $C_z \Pi_1$, and $\Pi_1^T \mathcal{P} \Pi_1$ vanish on this kernel. Using (48), it is easily seen that the three blocks

$$\begin{pmatrix} X & I \\ I & Y \end{pmatrix}, \quad \begin{pmatrix} AX + B\hat{C} & B\hat{D} \\ \hat{A} & \hat{B} \end{pmatrix}^T, \quad \begin{pmatrix} \hat{C} & \hat{D}C \\ \hat{A} & YA + \hat{B}C \end{pmatrix} \quad (49)$$

vanish on the very same subspace. Moreover, since $\text{diag}(\Pi_1, I)$ has a kernel of dimension k , the left-hand sides of the LMI's (38) both have a kernel of dimension k —the LMI's are nonstrict.

Conversely, if (49) vanishes on a common subspace of dimension at least k and if the LMI's (38) are nonstrict but the left-hand sides have a kernel of dimension at most k , one can construct a controller of order $n - k$ with (16) as follows: the matrix $I - \mathbf{X}\mathbf{Y}$ has a kernel of dimension equal to k such that one can find full rank matrices M , N with k columns satisfying $I - \mathbf{X}\mathbf{Y} = MN^T$. We define Π_1 , Π_2 as in (34) and observe that these matrices have full row rank. Since all the blocks in (49) vanish on a common subspace, it is possible to show that there exists a symmetric \mathcal{P} satisfying (34) and (unique) solutions A_K , B_K , C_K , D_K of (35). Then, we conclude again that the left-hand sides of (38) and (37) are identical. By assumption, the nonstrict versions of these inequalities hold. With the right-inverse Π_1^+ of Π_1 , we can transform (37) with $\text{diag}(\Pi_1^+, I)$ to arrive at the nonstrict inequalities that correspond to (16). Since Π_1 has a kernel

of dimension k and since the kernel dimension of the left-hand sides of (37) are at most k , it is not difficult to see that the matrices involved in (16) cannot have a kernel at all—the inequalities are strict.

We extract the following conditions for a general synthesis problem: matrices (49) vanish on a common subspace of dimension k , and any synthesis LMI is nonstrict such that the matrices involved have a kernel of at most dimension rk if r is the number of matrices Π_1 in the corresponding blockdiagonal congruence transformation.

VII. DESIGN EXAMPLES

The first example is of academic nature and illustrates the conservatism of this approach. The second example applies the methodology developed in this paper to the design of a dynamic positioning system (DPS) for a moored floating platform. All LMI-related computation was performed with the function `hinfmix` from the *LMI Control Toolbox* [18].

Example 7: Consider the three-state unstable plant with equations:

$$\begin{aligned} \dot{x} &= \begin{pmatrix} 0 & 10 & 2 \\ -1 & 1 & 0 \\ 0 & 2 & -5 \end{pmatrix} x + \begin{pmatrix} 1 \\ 0 \\ 1 \end{pmatrix} w + \begin{pmatrix} 0 \\ 1 \\ 0 \end{pmatrix} u \\ y &= x_2 + 2w \end{aligned}$$

and performance outputs

$$z_\infty = \begin{pmatrix} x_1 \\ u \end{pmatrix}, \quad z_2 = \begin{pmatrix} x_2 \\ x_3 \\ u \end{pmatrix}$$

(u and y denote the control and measurement as before). We are interested in the H_∞ performance from w to z_∞ and the H_2 performance from w to z_2 . The optimal H_2 performance from w to z_2 is 7.748 and is achieved for the controller

$$K_2(s) = \frac{-5.7275(s + 5.168)(s - 0.2711)}{(s + 5.164)(s^2 + 3.669s + 9.933)}.$$

When closing the loop on $K_2(s)$, the H_∞ performance from w to z_∞ is $\gamma = 23.586$.

Now consider the multiobjective problem

$$\text{Minimize } \|T_{wz_2}\|_2 \text{ subject to } \|T_{wz_\infty}\|_\infty < 23.6. \quad (50)$$

We know that $K_2(s)$ is the optimal solution since it is H_2 optimal and satisfies the H_∞ constraint. Hence, we can test the performance of our LMI approach to multiobjective design against this known optimal solution. Solving (50) with LMI optimization yields 8.956 as best constrained H_2 performance, which is 15% higher than the optimal value 7.748. The corresponding controller is

$$K_{\text{LMI}}(s) = \frac{-7.5924(s + 5.271)(s - 0.05601)}{(s + 5.272)(s^2 + 4.253s + 10.25)}.$$

Note that because we use a common Lyapunov function for both objectives, the LMI-optimal value 8.956 is only an upper bound on the closed-loop H_2 performance. In fact, the controller K_{LMI} has an actual H_2 performance of 8.07 (only 4% above the optimal value 7.748) and an H_∞ performance of

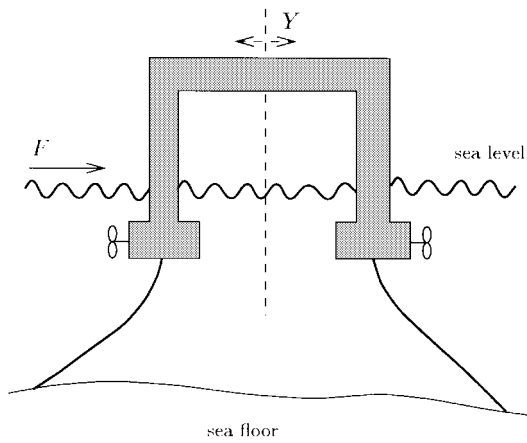

Fig. 1. Moored floating platform.

17.87 [24% lower than the H_∞ performance of the H_2 -optimal controller $K_2(s)$].

Summing up, this example shows that the LMI approach is indeed conservative, but not unduly so. Meanwhile, it offers the flexibility needed to improve over single-objective “optimal” techniques.

Example 8: This problem was provided by Prof. H. Kajiwara [20], [21]. The system is a floating platform depicted in Fig. 1. This platform is anchored to the bottom of the ocean and equipped with two thrusters. The goal is to minimize the drift Y resulting from the wave action by appropriate thruster control. The wave action can be summarized as a force F and a torque M . The force F consists of two components

$$F = F_1 + F_2$$

with the following characteristics.

- F_1 is a high-frequency high-amplitude excitation with small drifting effect. Due to its large magnitude, it cannot be countered by the thrusters.
- F_2 is a low-frequency low-amplitude excitation that can cause a large drift over time. This drifting action ought to be eliminated by proper thruster control.

The spectral energy of F_2 is concentrated between 0 and 1 rd/s, while that of F_1 is beyond 5 rd/s.

Let Y , ϕ , and F_u denote the horizontal drift, the angular deviation from the vertical axis, and the force delivered by the thrusters, respectively. The control objectives are as follows.

- Reject the drifting force F_2 by thruster control.
- Maintain $|Y|$ below 0.025 m and $|\phi|$ below 3 degrees (these figures are for a lab model of the platform).

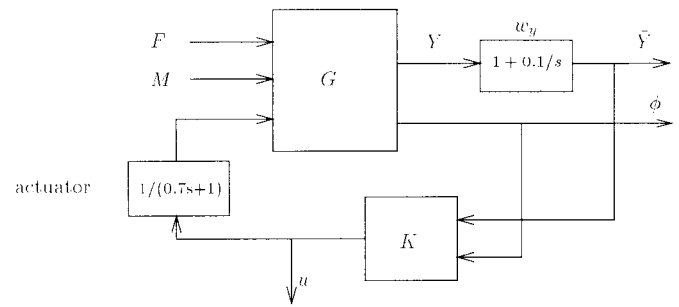

Fig. 2. Control structure.

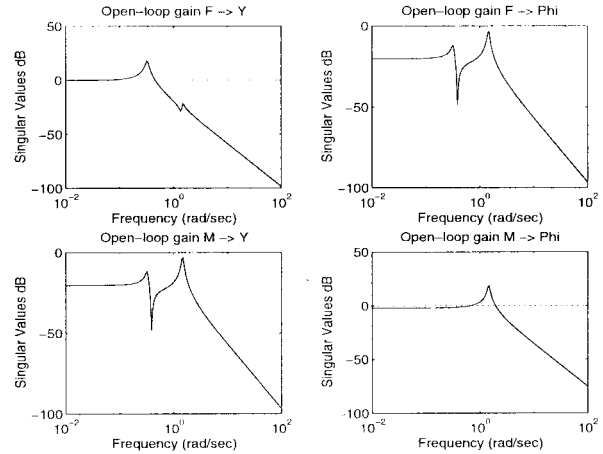

Fig. 3. Open-loop magnitude responses.

- Due to actuator limitations, keep $|F_u|$ below 0.25 N, and make sure that the thrusters are not excited by the high-frequency component F_1 .

Both Y and ϕ are measured, and the platform dynamics are described by the state-space equations

$$\dot{x} = Ax + B \begin{pmatrix} F \\ M \\ F_u \end{pmatrix}, \quad \begin{pmatrix} Y \\ \phi \end{pmatrix} = Cx$$

with A, B, C , as shown in (z) at the bottom of the page. The corresponding open-loop frequency responses from F, M to Y, ϕ are displayed in Fig. 3. In addition, the thruster dynamics are modeled by the first-order transfer function

$$F_u = d(s)u, \quad d(s) = \frac{1}{0.7s + 1}$$

where u denotes the control input and F_u the actual force delivered by the thrusters; see (z), shown at the bottom of the page.

$$\left(\begin{array}{c|c} A & B \\ \hline C & D \end{array} \right) = \left(\begin{array}{cccc|ccc} 0 & 0 & 1 & 0 & 0 & 0 & 0 \\ 0 & 0 & 0 & 1 & 0 & 0 & 0 \\ -0.1010 & -0.1681 & -0.04564 & -0.01075 & 0.1179 & 0.1441 & 0.1476 \\ 0.06082 & -2.1407 & -0.05578 & -0.1273 & 0.1441 & 1.7057 & -0.7557 \\ \hline 1 & 0 & 0 & 0 & 0 & 0 & 0 \\ 0 & 1 & 0 & 0 & 0 & 0 & 0 \end{array} \right) \quad (z)$$

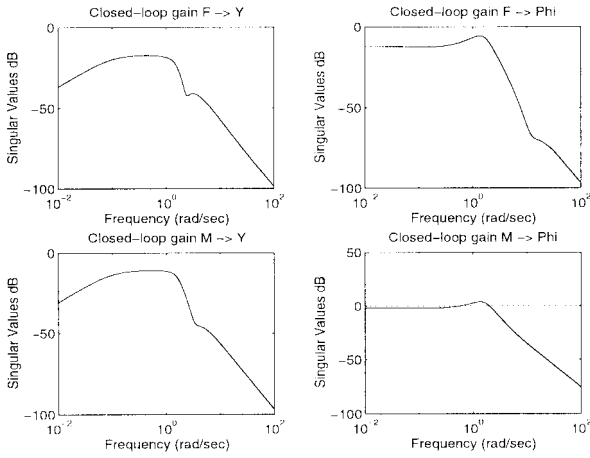

Fig. 4. Design #1: Closed-loop magnitude responses.

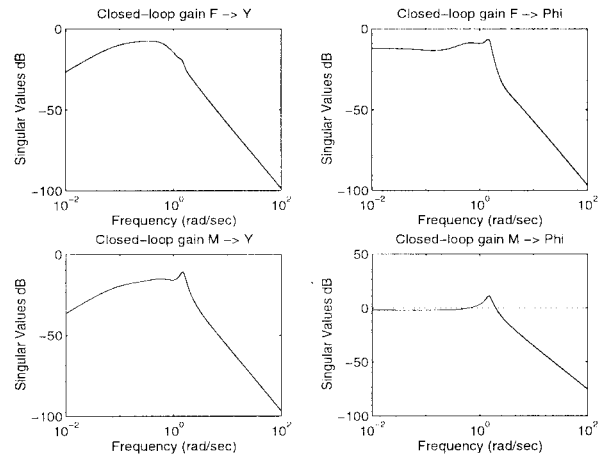

Fig. 6. Design #2: Closed-loop magnitude responses.

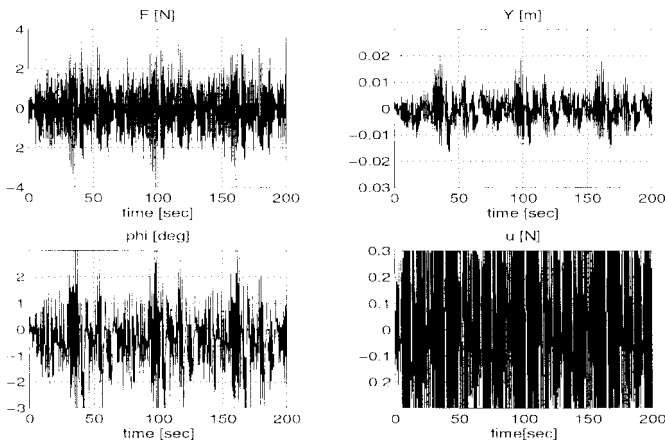

Fig. 5. Design #1: Closed-loop time responses.

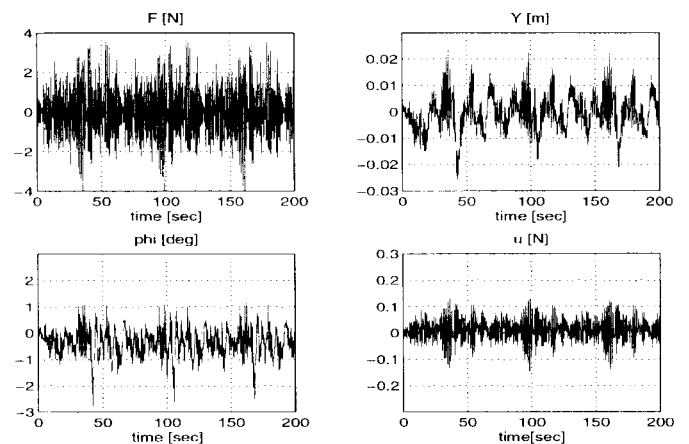

Fig. 7. Design #2: Closed-loop time responses.

For design purposes, we use the control structure displayed in Fig. 2. Here $K(s)$ denotes the controller to be designed, and the filter $w_1(s) = 1 + 0.1/s$ is used to enforce integral action on the output Y . Note that the controller actually implemented would consist of both $K(s)$ and $w_1(s)$ (Theorem 5). Our first design is a standard H_∞ synthesis aimed at minimizing $\|T\|_\infty$, where $T(s)$ is the closed-loop transfer defined by

$$\begin{pmatrix} \bar{Y} \\ w_\phi \phi \\ w_u u \end{pmatrix} = T(s) \begin{pmatrix} F \\ M \end{pmatrix}, \quad w_\phi = w_u = 0.1.$$

The optimal H_∞ performance is approximately 0.4, and the resulting closed-loop frequency and time responses are shown in Figs. 4 and 5, respectively. The driving force F used in the simulation comes from experimental data over a 200-s period.

While this H_∞ controller meets the rejection specifications on Y , it clearly violates the constraint on the maximum thruster effort. To reduce the control effort, we choose to minimize the cost of control in the H_2 norm while maintaining the H_∞ disturbance rejection constraint $\|T_1\|_\infty < 0.5$, where $T_1(s)$ is the closed-loop transfer from $\begin{pmatrix} F \\ M \end{pmatrix}$ to $\begin{pmatrix} \bar{Y} \\ w_\phi \phi \end{pmatrix}$. This is now

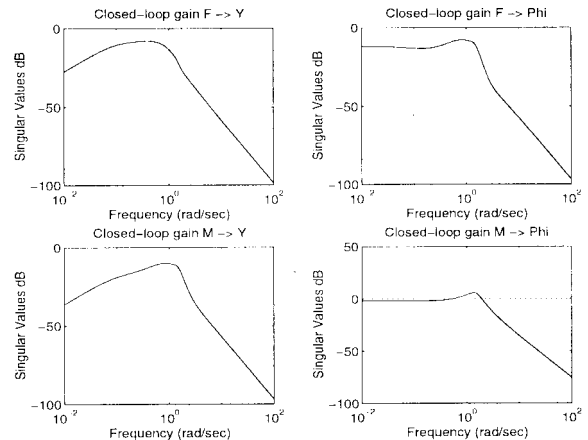

Fig. 8. Design #3: Closed-loop magnitude responses.

a multiobjective problem with an H_∞ constraint on $T_1(s)$ and an H_2 objective on the transfer function $T_2(s)$ mapping $\begin{pmatrix} F \\ M \end{pmatrix}$ to u . The corresponding LMI formulation consists of minimizing ν subject to the synthesis LMI's listed in V-B and V-C. The LMI optimization yields an H_2 performance of 1.22, and the closed-loop frequency and time responses for this second design appear in Figs. 6 and 7.

$$k_1(s) = -20.36 \frac{(s+1.43)(s+338.36)(s^2+254.03s+3.472 \times 10^4)(s^2+0.329s+3.677 \times 10^{-2})}{s(s+3.25)(s^2+172.11s+2.722 \times 10^4)(s^2+37.37s+1.051 \times 10^3)}$$

$$k_2(s) = 64.37 \frac{(s+1.43)(s+0.23)(s+411.41)(s^2+51.38s+2.065 \times 10^3)}{(s+3.25)(s^2+172.11s+2.722 \times 10^4)(s^2+37.37s+1.051 \times 10^3)}$$

All specifications are now met, and this second design would be deemed satisfactory. Yet, inspection of the closed-loop gain from M to ϕ reveals a residual resonance near 1 rd/s that, if excited, could boost the amplitude of ϕ . This is confirmed by the presence of a pair of poorly damped modes $-0.168 \pm 1.5i$ among the closed-loop poles. To dampen these modes, we can resort to an additional regional pole placement objective. For instance, we can impose that the closed-loop modes lie in the conic sector \mathcal{S} with tip at the origin and angle $\theta = 6\pi/7$. The characteristic function for this LMI region is [11]

$$f_{\mathcal{S}}(z) = \begin{pmatrix} \sin \theta(z + \bar{z}) & \cos \theta(z - \bar{z}) \\ \cos \theta(\bar{z} - z) & \sin \theta(z + \bar{z}) \end{pmatrix}.$$

To incorporate this additional constraint in the synthesis, we simply add the LMI (45) with $L = 0$ and

$$M = \begin{pmatrix} \sin \theta & \cos \theta \\ -\cos \theta & \sin \theta \end{pmatrix}$$

to the system of LMI's used in the second design. The resulting best H_2 performance is 2.6, and the closed-loop frequency responses are shown in Fig. 8. The time responses are essentially similar to those for the second design. Note that the resonance has been attenuated, the pair of badly damped modes being moved to $-0.4 \pm 1.46i$. This final design gives the stable control law $u = k_1(s)Y + k_2(s)\phi$ as given in the equation shown at the top of the page.

REFERENCES

- [1] J. Abedor, K. Nagpal, P. P. Khargonekar, and K. Poolla, "Robust regulation in the presence of norm-bounded uncertainty," *IEEE Trans. Automat. Contr.*, vol. 40, pp. 147–153, 1995.
- [2] J. Abedor, K. Nagpal, and K. Poolla, "Robust regulation with \mathcal{H}_2 performance," *Syst. Contr. Lett.*, vol. 23, pp. 431–443, 1994.
- [3] ———, "A linear matrix inequality approach to peak-to-peak gain minimization," *Int. J. Robust Nonlinear Contr.*, vol. 6, pp. 899–927, 1996.
- [4] B. D. O. Anderson and S. Vongpanitlerd, *Network Analysis*. Englewood Cliffs, NJ: Prentice-Hall, 1973.
- [5] R. Bambang, E. Shimemura, and K. Uchida, "Mixed H_2/H_∞ control with pole placement, state-feedback case," in *Proc. Amer. Contr. Conf.*, 1993, pp. 2777–2779.
- [6] B. R. Barmish, "Stabilization of uncertain systems via linear control," *IEEE Trans. Automat. Contr.*, vol. AC-28, pp. 848–850, 1983.
- [7] D. S. Bernstein and W. M. Haddad, "LQG control with an H_∞ performance bound: A Riccati equation approach," *IEEE Trans. Automat. Contr.*, vol. 34, pp. 293–305, 1989.
- [8] S. P. Boyd and L. El Ghaoui, "Method of centers for minimizing generalized eigenvalues," *Lin. Alg. Appl.*, vol. 188, pp. 63–111, 1993.
- [9] S. Boyd, L. El Ghaoui, E. Feron, and V. Balakrishnan, *Linear Matrix Inequalities in Systems and Control Theory*. Philadelphia, PA: SIAM, 1994.
- [10] M. K. K. Cevik and J. M. Schumacher, "The regulator problem with robust stability," Rep. BS-R9321, CWI, Amsterdam, 1993.
- [11] M. Chilali and P. Gahinet, " H_∞ design with pole placement constraints: An LMI approach," *IEEE Trans. Automat. Contr.*, vol. 41, pp. 358–367, 1996.
- [12] E. J. Davison, "The robust control of a servomechanism problem for linear time-invariant multivariable systems," *IEEE Trans. Automat. Contr.*, vol. AC-21, pp. 25–34, 1976.
- [13] J. C. Doyle, K. Zhou, K. Glover, and B. Bodenheimer, "Mixed \mathcal{H}_2 and \mathcal{H}_∞ performances objectives II: Optimal control," *IEEE Trans. Automat. Contr.* vol. 39, pp. 1575–1587, 1994.
- [14] B. A. Francis, "The linear multivariable regulator problem," *SIAM J. Contr. Optim.*, vol. 15, pp. 486–505, 1977.
- [15] ———, *A Course in H_∞ Control Theory*, Lecture Notes in Control and Information Sciences, no. 88. Berlin: Springer-Verlag, 1987.
- [16] P. Gahinet and P. Apkarian, "A linear matrix inequality approach to H_∞ control," *Int. J. Robust Nonlinear Contr.*, vol. 4, pp. 421–448, 1994.
- [17] P. Gahinet, "Explicit controller formulas for LMI-based H_∞ synthesis," *Automatica*, to appear.
- [18] P. Gahinet, A. Nemirovski, A. J. Laub, and M. Chilali, *LMI Control Toolbox*. Natick, MA: The MathWorks, 1995.
- [19] T. Iwasaki and R. E. Skelton, "All controllers for the general \mathcal{H}_∞ control problem: LMI existence conditions and state space formulas," *Automatica*, vol. 30, pp. 1307–1317, 1994.
- [20] M. Nakamura, W. Koterayama, H. Kajiwara, and T. Mitamura, "Application of a dynamic positioning system to a moored floating platform," in *Proc. 4th Int. Offshore Polar Eng. Conf.*, 1994, pp. 190–197.
- [21] H. Kajiwara, W. Koterayama, M. Nakamura, and P. Gahinet, "LMI-based design of dynamic positioning control laws for a moored floating platform model," in *Proc. 14th SICE Kyushu Branch Annu. Conf.*, 1995, pp. 181–184.
- [22] P. P. Khargonekar and M. A. Rotea, "Mixed H_2/H_∞ control: A convex optimization approach," *IEEE Trans. Automat. Contr.*, vol. 39, pp. 824–837, 1991.
- [23] I. Masubuchi, N. Suda, and A. Ohara, "LMI-based controller synthesis: A unified formulation and solution," in *Proc. Amer. Contr. Conf.*, 1995, pp. 3473–3477.
- [24] I. Masubuchi, A. Ohara, and N. Suda, "LMI-based controller synthesis: A unified formulation and solution," *Int. J. Robust Nonlinear Contr.*, submitted.
- [25] A. Nemirovski and P. Gahinet, "The projective method for solving linear matrix inequalities," *Math. Programming Series B*, to be published; also in *Proc. Amer. Contr. Conf.*, 1994, pp. 840–844.
- [26] Y. Nesterov and A. Nemirovski, *Interior Point Polynomial Methods in Convex Programming: Theory and Applications*. Philadelphia, PA: SIAM, 1994.
- [27] M. A. Rotea, "The generalized \mathcal{H}_2 control problem," *Automatica*, vol. 29, pp. 373–385, 1993.
- [28] C. Scherer, "The Riccati inequality and state-space H_∞ -optimal control," Ph.D. dissertation, Univ. Würzburg, Germany, 1990.
- [29] ———, "Mixed H_2/H_∞ control," in *Trends in Control, A European Perspective*, A. Isidori, Ed. Berlin: Springer-Verlag, 1995, pp. 173–216.
- [30] ———, "From LMI analysis to multichannel mixed LMI synthesis: A general procedure," *Selected Topics Identification, Modeling Contr.*, vol. 8, pp. 1–8, 1995.
- [31] W. Sun, P. P. Khargonekar, and D. Shim, "Solution to the positive real control problem for linear time-invariant systems," *IEEE Trans. Automat. Contr.*, vol. 39, pp. 2034–2046, 1994.
- [32] L. Vandenberghe and S. Boyd, "Primal-dual potential reduction method for problems involving matrix inequalities," *Math. Program. Series B*, vol. 69, pp. 205–236, 1995.
- [33] J. C. Willems, "Least-squares stationary optimal control and the algebraic Riccati equation," *IEEE Trans. Automat. Contr.*, vol. AC-21, pp. 319–338, 1971.



Carsten Scherer (M'94) was born in Lohr, Germany. He received the diploma and the Ph.D. degree in mathematics from the University of Würzburg, Germany, in 1987 and 1991, respectively.

He was appointed a Research Assistant from 1988 until 1993 at University of Würzburg, Germany. In 1989, he visited the Mathematics Institute of the University of Groningen, The Netherlands, for six months. In 1992, he received a Post-Doctoral Fellowship from the "Deutsche Forschungsgemeinschaft" (DFG) to spend six months at the University of Michigan, Ann Arbor, and six months at Washington University, St. Louis, MO, respectively. In 1993, he joined the Mechanical Engineering Systems and Control Group at Delft University of Technology, The Netherlands, where he currently holds a position as Assistant Professor ("Universitair Docent"). His research interests include robust control for linear and nonlinear systems, geometric control, the theory of linear matrix inequalities, Riccati inequalities, and Riccati equations in control.



Mahmoud Chilali was born in Casablanca, Morocco, in 1966. He received the engineer diplomas from the Ecole Polytechnique and the Ecole Nationale Supérieure de Techniques Avancées, Paris, France, in 1990 and 1992, respectively, and the Ph.D. degree from the French Institut National de Recherche en Informatique et Automatique (INRIA) in 1996.

His research interests include robust and multi-objective control and LMI optimization.



Pascal Gahinet (M'90) graduated from the Ecole Polytechnique in 1984 and from the ENSTA, Paris, France, in 1986, and received the M.S. degree in electrical and computer engineering and the Ph.D. degree in system theory, both from the University of California, Santa Barbara, in 1987 and 1989, respectively.

He was with the French National Research Institute in Computer and Control Sciences (INRIA) from 1990 to 1995, taught control at ENSTA from 1991 to 1994, and also served as a Consultant for THOMSON-CSF and Aérospatiale during this period. He is now with The MathWorks, Inc., Natick, MA. His research interests include robust control theory, linear matrix inequalities, numerical linear algebra, and numerical software for control. He is a coauthor of the *LMI Control Toolbox* and the *Control System Toolbox* for use with MATLAB.